

# SHOREMASTER®

# Hammond Lumber Company

FREE  
DELIVERY\*  
LOCAL SAME DAY

INSTALLATION  
AVAILABLE  
WITHIN 48 HOURS

## 2018 PRODUCT CATALOG

\*FREE DELIVERY WITHIN LOCAL DELIVERY AREA, SEE PAGE 72 FOR DETAILS.

# YOUR PASSION FUELS OURS.

*Discover the ShoreMaster difference.*

For nearly three decades ShoreMaster has offered the broadest line of waterfront equipment in the industry through Hammond Lumber Company. There is no one style of dock or lift that fits every situation.

Let Hammond Lumber Company match you with the right equipment for your waterfront. We pride ourselves on providing safe, dependable, easy to use products that are as beautiful as your lake home. Our docks are built with quality maintenance free aluminum so you can relax and enjoy your time at the lake for years to come.





# CONTENTS

● <b>RAFTS</b>	<b>3</b>
Polyethylene Swim Raft	4
Aluminum Frame Swim Raft	5
Rip Raft	6
● <b>DECKING OPTIONS</b>	<b>8</b>
● <b>DOCKS</b>	<b>13</b>
Infinity RS4	14
Infinity RS4 Curve	18
Infinity RS7	20
QuickConnect™ QuickSteps	25
QuickConnect™ Hinges	27
Gangways	28
Infinity TS9	30
PolyDock	34
Floating FTS9	38
Shoreport™	42
ShoreMaster Flotation	43
RhinoFloat	44
● <b>QUICKCONNECT™</b>	<b>46</b>
QuickConnect™ Accessories	47
● <b>ALUMINUM LIFTS</b>	<b>50</b>
Vertical Lift	51
Pontoon & Tri-toon Lifts	53
Hydraulic Lift	57
Heavy Capacity Lift	59
PWC Lifts	60
● <b>CANOPIES</b>	<b>62</b>
Canopy Covers	64
Traditional Canopy	65
Hip Roof Canopy	67
● <b>BOAT LIFT POWER UNITS</b>	<b>70</b>
Lift Mate™	70
Lift Boss™	70
<b>DELIVERY FEES</b>	<b>72</b>
<b>SHOREMASTER'S LIMITED WARRANTY</b>	<b>73</b>
<b>DESIGN YOUR DOCK</b>	<b>75</b>
<b>SPECIFICATIONS</b>	<b>77</b>
<b>ACCESSORIES</b>	<b>81</b>

\*All prices may be subject to change.

# RAFTS



# POLYETHYLENE SWIM RAFT

## *benefits*

### SIZE

7.5 foot by 9.5 foot nonskid deck surface

### SAFETY FIRST

One piece, all poly swim raft with reflectors on each corner provide additional safety.

### REMARKABLE STRENGTH

The raft weight is approximately 325 pounds and features a 3,000-pound capacity.

### PROVEN PERFORMANCE

The Polyethylene Swim Raft is backed by our Standard three-year warranty.

### COLOR OPTIONS

Available in Yellow or Gray.



**PIVOT LADDER**  
OPTIONAL



YELLOW



GRAY

## MODELS AND SPECIFICATIONS

### POLY SWIM RAFTS

RAFTPOLYEL	90" x 114" Polyethylene Swim Raft - Yellow
RAFTPOLYGRAY	90" x 114" Polyethylene Swim Raft - Gray

### NET PRICE

\$1,209.00
\$1,209.00

### INSTALLATION ACCESSORIES

24CBA	24" Cement Boat Anchor	\$39.00
ROPEBAG	Rope Bag (INCLUDES CONES, ROPE, RING, LADDER CLIPS)	\$59.00

### NET PRICE

\$39.00
\$59.00

SWIM RAFT PRICING DOES NOT INCLUDE LADDER

### LADDER OPTIONS

3LADPOLY	3 Step Pivot Ladder for Poly Swim Raft	\$299.00
4LADPOLY	4 Step Pivot Ladder for Poly Swim Raft	\$369.00
5LADPOLY	5 Step Pivot Ladder for Poly Swim Raft	\$459.00

# ALUMINUM FRAME SWIM RAFT

## benefits

### SIZE

8 foot by 8 foot

### REMARKABLE STRENGTH

The all-aluminum frame, with attached poly floats, will give you and your family years of maintenance free waterfront enjoyment.

### PROVEN PERFORMANCE

The Aluminum Frame Swim Raft is backed by the ShoreMaster 15/5/2 warranty.

### DECKING OPTIONS

Available in Premium Cedar, Plain Aluminum, and White Aluminum.



**PIVOT LADDER**  
OPTIONAL



PLAIN ALUMINUM

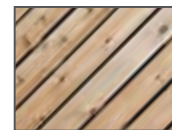

PREMIUM CEDAR

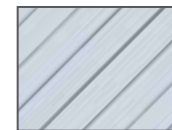

WHITE ALUMINUM

## MODELS AND SPECIFICATIONS

### ALUMINUM FRAME SWIM RAFTS

MODEL	DESCRIPTION	NET PRICE
RAFTRC	8' X 8' Aluminum Swim Raft - Premium Cedar Deck Actual Weight = 400 lbs. (fixed deck panels)	\$1,899.00
RAFTAD	8' X 8' Aluminum Swim Raft - Plain Aluminum Deck Actual Weight = 200 lbs. (excluding removable panels)	\$2,339.00
RAFTPA	8' x 8' Aluminum Swim Raft - White Aluminum Deck Actual Weight = 200 lbs. (excluding removable panels)	\$2,559.00

### BOAT ANCHORS

24CBA	24" Cement Boat Anchor	\$39.00
-------	------------------------	---------

### LADDER OPTIONS

3LADQC	3 Step QuickConnect™ Ladder** (34" FROM TOP OF DOCK TO BOTTOM OF LADDER)	\$289.00
4LADQC	4 Step QuickConnect™ Ladder** (46" FROM TOP OF DOCK TO BOTTOM OF LADDER)	\$339.00
5LADQC	5 Step QuickConnect™ Ladder** (58" FROM TOP OF DOCK TO BOTTOM OF LADDER)	\$399.00

### QUICKCONNECT™ ACCESSORY BRACKET

RS4QCBR	RS4 QuickConnect™ Accessory Bracket	\$36.00
---------	-------------------------------------	---------

### BUMPERS

CDB	Rhino Corner Bumpers - Blue (EACH)	\$39.00
-----	------------------------------------	---------

SWIM RAFT PRICING DOES NOT INCLUDE LADDER OR BUMPERS \*\*REQUIRES 2 EACH QUICKCONNECT™ ACCESSORY BRACKETS.

# RIP RAFT

## benefits

### SIZE

7.5 foot by 7.5 foot nonskid deck surface.

### LADDER OPTIONS

With 2 ladder options available, you can easily gain access to your Rip Raft.

### REMARKABLE STRENGTH

The raft weight is approximately 165 pounds and features a 1,200 pound capacity.

### PROVEN PERFORMANCE

The Rip Raft is backed by our Standard 3 year warranty.

### COLOR OPTIONS

Available in tan or orange



**4 STEP NYLON LADDER**  
OPTIONAL



**2 STEP ALUMINUM LADDER**  
OPTIONAL



ORANGE

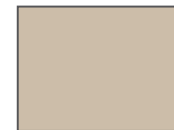

TAN

## MODELS AND SPECIFICATIONS

### RIP RAFT SWIM RAFTS

ROCKRAFTTAN	7.5' x 7.5' Rip Raft - Tan
ROCKRAFTORG	7.5' x 7.5' Rip Raft - Orange

### NET PRICE

\$879.00
\$879.00

### LADDER OPTIONS

NYLAD4	4 Step Nylon Ladder
RIPLAD2	2 Step Aluminum Ladder for Rip Raft

### NET PRICE

\$57.00
\$215.00

SWIM RAFT PRICING DOES NOT INCLUDE LADDER



**SHOREMASTER**

**SHOREMASTER**

NY 1546 KB





# DECKING OPTIONS

When you envision your perfect dock, you'll always come back to the style and color of decking you want. That's why you'll find more decking options with ShoreMaster than you'll find anywhere else. Love the feel of natural wood on your bare feet? Or are you simply looking for the perfect maintenance free solution? No matter what you're searching for, you'll find your perfect decking with one of the eight premium options available from ShoreMaster.

## **NATURAL WOOD:**

- Premium Cedar
- Hardwood IPE

## **MAINTENANCE FREE:**

- Aluminum
- Glacier
- Vertex

# DECKS

ShoreMaster dock systems feature removable decking panels, but why?

First, we build the strength of our dock systems into the frame sections themselves. We do not rely on the decking attachment to provide the system its strength. Second, it's better for the owners of our systems. It provides you options and makes installation, removal, upkeep and upgrades so much easier.

Why choose a removable deck panel system?

- Panels can be removed for installation/removal, making sections lighter and easier to carry and install.
- Opportunity to upgrade the look of your system without replacing frame sections.
- Easily replace individual panels if necessary - no need to replace an entire dock section.
- Trust that the integrity and strength of your system is built into the frame itself

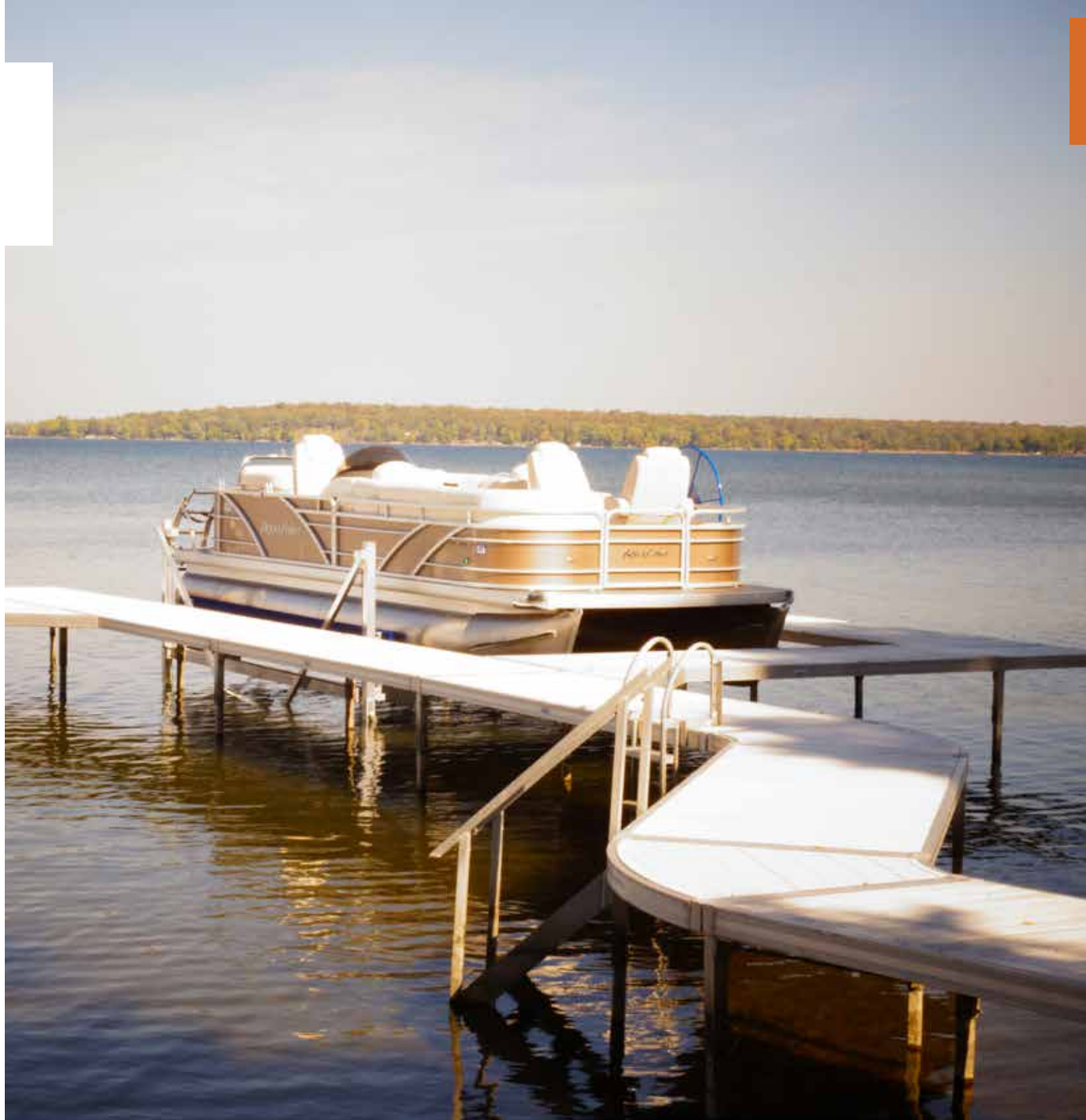

# DECKING OPTIONS

CHOOSE FROM THE MOST DECKING OPTIONS OF THE INDUSTRY

## PREMIUM CEDAR

CLASSIC | NATURAL | WARM

When you select natural Premium Cedar wood decking for your dock system, you want the material to be of the highest quality. We source Premium Cedar boards that contain more heartwood so you get decking that will last longer and look great, with minimal maintenance. Nothing feels better on your bare feet than the soft, natural beauty of Premium Cedar decking from ShoreMaster.

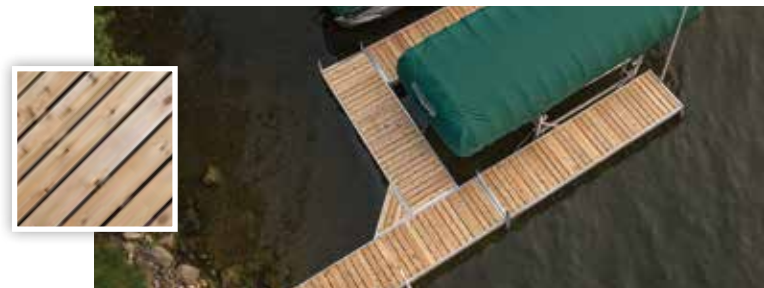

## HARDWOOD IPE

LUXURIOUS | DURABLE | NATURAL | LOW MAINTENANCE

You want real wood decking with low maintenance requirements. Hardwood IPE decking from ShoreMaster adds stability to your dock system because its density adds additional weight to the overall dock system. IPE decking feels firm and stable under foot and its natural oils resist warping, insects and decay to provide you with a natural wood decking option that's remarkably low maintenance.



## TRADITIONAL WOODGRAIN ALUMINUM

MAINTENANCE FREE | POWDER COATED | DURABLE

You want all of the natural beauty of real wood decking, but you need it to be maintenance free. Woodgrain aluminum decking gives just that. Woodgrain powder coated aluminum decking won't rot, twist, warp or decay, so your dock will look like new year after year. Get all of the benefits of natural wood, without the hassle of annual wood decking maintenance.



## GRAY OAK WOODGRAIN ALUMINUM

MAINTENANCE FREE | POWDER COATED | DURABLE

Add timeless beauty and durability to your dock system with our Gray Oak woodgrain aluminum decking. Utilizing an Italian process paint application, our woodgrain decking features a non-repeating pattern so you get the uniqueness and natural appearance of wood without all the maintenance and hassle. Plus, the treaded surface provides you with a safe, cool to the touch decking option that's as comfortable as it is beautiful.



# DECKING OPTIONS

MORE CHOICES. PREMIUM OPTIONS.

## PLAIN ALUMINUM

MAINTENANCE FREE | DURABLE | WORK READY

Whether you plan to use your dock for serious work or serious enjoyment, you'll be glad you chose the ultimate in maintenance free decking. Plain aluminum decking from ShoreMaster offers a lightweight, maintenance free, incredibly durable dock surface that is perfect for work or play.



## WHITE ALUMINUM

POWDER COATED | MAINTENANCE FREE | DURABLE | STAYS COOL

Add years of worry free, maintenance free enjoyment to your lake living experience with ShoreMaster's white aluminum panels. Powder coated in brilliant white, you'll get a clean, modern looking surface that stays cool to the touch even on warm summer days. The treaded surface provides you with a safe decking option that's as comfortable as it is beautiful.



## TAN ALUMINUM

POWDER COATED | MAINTENANCE FREE | DURABLE | STAYS COOL

ShoreMaster's Tan Aluminum decking is among our most popular aluminum decking options as it provides a safe, comfortable decking surface. Powder coated in natural tan, you get an attractive decking option to complement your waterfront property. Tan aluminum decking features a treaded surface and stays cool to the touch, so your family can truly enjoy every summer day on your dock.



# DECKING OPTIONS

MORE CHOICES. PREMIUM OPTIONS.

## VERTEX™ (TAN OR GRAY)

SHOREMASTER EXCLUSIVE | MAINTENANCE FREE | SLIP RESISTANT

If you want a maintenance free decking option that is truly unique, you want the ShoreMaster exclusive Vertex™ decking. With a flagstone pattern, Vertex™ feels smooth on bare feet, looks great, and is incredibly slip resistant. Once you've walked on Vertex™ decking, you won't want anything else for your family.



## GLACIER (TAN OR GRAY)

LIGHT WEIGHT | MAINTENANCE FREE | SLIP RESISTANT

Glacier Decking is one of the easiest decking options to own because the open concept of the design will not collect dirt and debris. This allows it to dry faster and stay clean longer. You'll be able to enjoy a great looking dock system without any of the decking maintenance and cleaning. Glacier Decking is easy on your feet, and its slip resistant surface allows you to safely and comfortably enjoy time spent on your dock.



# DOCKS

Take your waterfront experience to the next level with the convenience, safety and quality you can only find with a ShoreMaster aluminum dock system. Extremely lightweight yet remarkably stable, each dock can be configured to meet virtually any desired layout and look.

Docks, decking, accessories and lifts all work seamlessly together to make it easier for you to get out on the water today – and keep you returning for countless tomorrows.

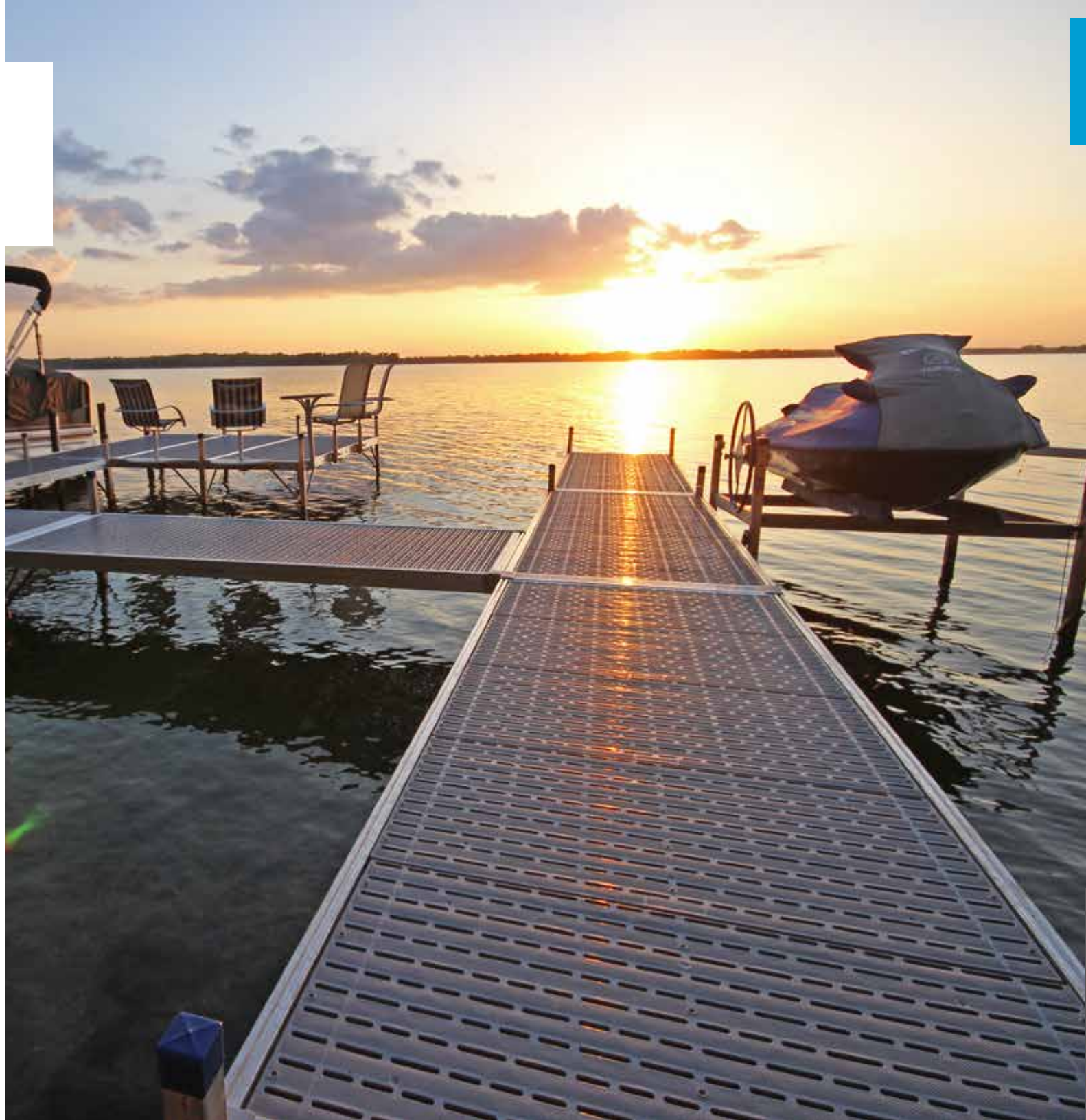

# INFINITY RS4 DOCK

VERSATILE DESIGN. ENDLESS CONFIGURATIONS.



**ENDLESS CONFIGURATIONS**  
for virtually unlimited  
layouts or designs.



## *benefits*

### UNLIMITED CONFIGURABILITY

Maximize your shoreline with curved framed sections for clean lines and virtually unlimited configurability.

### PREMIUM STABILITY

5-Sided Dock Legs™ provide three points of contact for unmatched dock stability and safety.

### EASY CUSTOMIZATION

The QuickConnect™ accessory system makes it easy to install and remove accessories without tools.

### REMARKABLE STRENGTH

4" side rails and expertly welded aluminum frames provide remarkable strength and durability.

### THE MOST DECKING OPTIONS

Achieve your desired look by choosing from ShoreMaster's 8 premium decking options including Cedar, Vertex™, Aluminum and more.

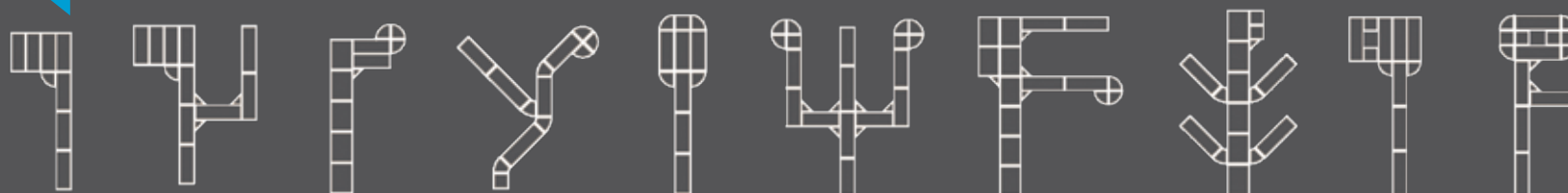

# INFINITY RS4 DOCK

## STANDING DOCK AND ACCESSORIES

### MODELS AND SPECIFICATIONS

#### 4' X 10' RS4 STANDING DOCK WITH PANELS

		NET PRICE
41ORCD	4' x 10' Dock - Premium Cedar Deck	\$899.00
41OIPED	4' x 10' Dock - Hardwood IPE Deck	\$1,829.00
41OAD	4' x 10' Dock - Plain Aluminum Deck	\$1,099.00
41OPED	4' x 10' Dock - White Aluminum Deck	\$1,299.00
41OTPD	4' x 10' Dock - Tan Aluminum Deck	\$1,299.00
41OWGD	4' x 10' Dock - Traditional Woodgrain Aluminum Deck	\$1,399.00
41OGOWGD	4' x 10' Dock - Gray Oak Woodgrain Aluminum Deck	\$1,399.00
41OVD	4' x 10' Dock - Vertex™ Deck	\$1,229.00
41OTGD	4' x 10' Dock - Tan Glacier Deck	\$1,199.00
41OGGD	4' x 10' Dock - Gray Glacier Deck	\$1,199.00

(ALL STANDING DOCKS INCLUDE 2 INFINITY SINGLE LEG POCKETS AND 2 FOOT PADS)

#### 6' X 8' RS4 STANDING DOCK WITH PANELS

68RCD	6' x 8' Dock - Premium Cedar Deck	\$1,229.00
68IPED	6' x 8' Dock - Hardwood IPE Deck*	\$2,399.00
68AD	6' x 8' Dock - Plain Aluminum Deck*	\$1,499.00
68PED	6' x 8' Dock - White Aluminum Deck*	\$1,549.00
68TPD	6' x 8' Dock - Tan Aluminum Deck*	\$1,549.00
68WGD	6' x 8' Dock - Traditional Woodgrain Aluminum Deck*	\$1,699.00
68GOWGD	6' x 8' Dock - Gray Oak Woodgrain Aluminum Deck*	\$1,699.00
68VD	6' x 8' Dock - Vertex™ Deck*	\$1,899.00

(ALL STANDING DOCKS INCLUDE 2 INFINITY SINGLE LEG POCKETS AND 2 FOOT PADS)

#### QUICKCONNECT™ QUICK STEPS

QUICKSTEPS4	4-Step Quick Steps with handrails	\$1,199.00
QUICKSTEPS6	6-Step Quick Steps with handrails	\$1,399.00
QSR4CB	Infinity RS4 Quick Step Bracket	\$129.00
QSR7CB	Infinity RS7 Quick Step Bracket	\$129.00
QTS9CB	Infinity TS9 Quick Step Bracket	\$129.00
QSUNICB	Quick Step QuickConnect™ Universal Bracket	\$129.00
QSSK	Quick Step Splice Kit	\$89.00

#### DOCK LADDERS

3LADQC	3 Step QuickConnect™ Ladder** (34" FROM TOP OF DOCK TO BOTTOM OF LADDER)	\$289.00
4LADQC	4 Step QuickConnect™ Ladder** (46" FROM TOP OF DOCK TO BOTTOM OF LADDER)	\$339.00
5LADQC	5 Step QuickConnect™ Ladder** (58" FROM TOP OF DOCK TO BOTTOM OF LADDER)	\$399.00

#### QUICKCONNECT™ ACCESSORY BRACKET

RS4QCBR	RS4 QuickConnect™ Accessory Bracket	\$36.00
---------	-------------------------------------	---------

## options



#### QUICKCONNECT™ PIVOT LADDER

Crafted with alloy aluminum construction and available in 3, 4 and 5-step, the QuickConnect™ Pivot Ladder will enhance the use of your waterfront.



#### QUICKCONNECT™ SYSTEM

Allows for easy, no-tool attachment and movement of accessories, including off deck benches, vertical bumpers, steps and more.



#### QUICKCONNECT QUICK STEPS

Quick Steps provide safe, stable access to the water. A wider width & step tread means more stability at the waterfront. Available in 4 or 6-steps.



#### DOCK STEPS WITH HANDRAIL

For swimming and safety, ShoreMaster steps are essential. They are available in 4 and 6-step versions and feature marine alloy aluminum construction with stainless steel hardware. Made to fit most styles of stationary dock and wheel-in dock.

\*SPECIAL ORDER. \*\*REQUIRES 1 EACH QUICKCONNECT™ ACCESSORY BRACKET.

\*\*REQUIRES 2 EACH QUICKCONNECT™ ACCESSORY BRACKETS.



# INFINITY RS4 DOCK

## STANDING DOCK ACCESSORIES

### MODELS AND SPECIFICATIONS

#### DOCK STEPS WITH HANDRAIL

		NET PRICE
4DOCKSTEPS	4 Dock Steps with Handrail** (ADJUSTS FROM 31" TO 43" - TOP OF DOCK TO BOTTOM OF LAKE)	\$529.00
6DOCKSTEPS	6 Dock Steps with Handrail** (ADJUSTS FROM 45" TO 57" - TOP OF DOCK TO BOTTOM OF LAKE)	\$629.00

#### DOCK BUMPERS

QCVCOB	QuickConnect™ Vertical Corner Bumper - Blue (WITH HARDWARE BOX)*	\$259.00
10DB	10' Dockside Bumper	\$69.00
VDB	QuickConnect™ Vertical Dock Bumper (EACH)*	\$124.00
CDB	Rhino Corner Bumper - Blue	\$39.00
VDBHA	Vertical Dock Bumper Horizontal Adaptor	\$18.00

#### DOCK LEG POSTS

3LEGP	3' Dock Leg Post (EACH)	\$55.00
5LEGP	5' Dock Leg Post (EACH)	\$79.00
7LEGP	7' Dock Leg Post (EACH)†	\$99.00
9LEGP	9' Dock Leg Post (EACH)†	\$131.00
12LEGP	12' Dock Leg Post (EACH)†	\$177.00

#### DOCK LEG ACCESSORIES

UNIDWBPAIR	Diagonal Deep Water Brace (PAIR)	\$185.00
HEAVYDWB	4' Heavy Duty Deep Water Brace (EACH)	\$208.00
6HEAVYDWB	6' Heavy Duty Deep Water Brace (EACH)	\$228.00
SHORTSALP	Short Single Adjustable Leg Pocket (EACH)	\$54.00
ISLP	Infinity Single Leg Pocket	\$85.00
AFP	Adjustable Foot Pad (EACH)	\$51.00

#### DOCK ACCESSORIES

QCRC	QuickConnect™ Rope Cleat	\$33.00
DAUNIUMBR	Umbrella Holder	\$72.00
QCFLAG	QuickConnect™ Flagpole Holder*	\$97.00
FLAGPOLE	20' Anodized Aluminum Flag Pole (INCLUDES 3' X 5' AMERICAN FLAG)	\$559.00
TLBQC	QuickConnect™ Lakeview Bench**	\$349.00
LVARM	Arm Rest for Lakeview Bench	\$149.00
CANOERACK	QuickConnect™ Canoe, Kayak, Paddle Board Rack**	\$249.00
DBLKAYAKKIT	Double Kayak Kit (MUST PURCHASE CANOE RACK SEPARATELY)	\$149.00
FRHOLDER	Fishing Rod Holder*	\$59.00
FURNITURE	QuickConnect™ Dock Furniture (2 CHAIRS, TABLE AND UMBRELLA)***	\$925.00
QC4HR	QuickConnect™ 4' Handrail**	\$169.00
QC6HR	QuickConnect™ 6' Handrail**	\$199.00
QC8HR	QuickConnect™ 8' Handrail**	\$289.00
SUPBR	QuickConnect™ Dual Stand-Up Paddleboard Rack**	\$529.00
UNIHANDRAIL	10' Uni-Dock Handrail***	\$339.00
SDLSPW	LED White Solar Powered Dock Lights (PAIR)	\$59.00

\*REQUIRES USE OF DIAGONAL DEEP WATER BRACE. \*\*REQUIRES 1 EACH QUICKCONNECT™ ACCESSORY BRACKET.  
 \*\*\*REQUIRES 2 EACH QUICKCONNECT™ ACCESSORY BRACKETS. \*\*\*\*REQUIRES 3 EACH QUICKCONNECT™ ACCESSORY BRACKETS.

## options

### DIAGONAL DEEP WATER BRACE

The easy installation will add support to your dock increasing its stability. For deep water applications (5' or greater).



### 5-SIDED DOCK LEGS™

ShoreMaster's 5-Sided Dock Legs™ provide three points of contact for unmatched dock stability and safety. The T-handle adjustment system means no tools are necessary to make height modifications.



### QUICKCONNECT™ DOCK FURNITURE

Relax on your dock in style. The QuickConnect™ Dock Furniture comes with 2 chairs, a table, and an umbrella.



### QUICKCONNECT™ ROPE CLEAT

Provides a convenient tie-up for visiting boats and can be positioned anywhere along your dock with QuickConnect™.



### DOCK BUMPERS

Provide additional protection for your boat and swimmers. The QuickConnect™ Vertical Dock Bumper is aluminum channeled with a vinyl surface and adjustable to help prevent your boat from going over or under your dock. Three types of bumpers are available, including 10' dock bumpers, corner dock bumpers, and vertical dock bumpers.



# INFINITY RS4 DOCK

## STANDING DOCK ACCESSORIES

### MODELS AND SPECIFICATIONS

#### 4' LONG SHORESIDE PIVOT RAMP

		NET PRICE
4RAMPRC	4' Shoreside Pivot Ramp - Premium Cedar Deck	\$329.00
4RAMPIE	4' Shoreside Pivot Ramp - Hardwood IPE Deck	\$759.00
4RAMPAL	4' Shoreside Pivot Ramp - Plain Aluminum Deck	\$399.00
4RAMPPA	4' Shoreside Pivot Ramp - White Aluminum Deck	\$529.00
4RAMPTP	4' Shoreside Pivot Ramp - Tan Aluminum Deck	\$529.00
4RAMPGOWG	4' Shoreside Pivot Ramp - Gray Oak Woodgrain Aluminum Deck	\$539.00
4RAMPWG	4' Shoreside Pivot Ramp - Traditional Woodgrain Aluminum Deck	\$539.00
4RAMPV	4' Shoreside Pivot Ramp - Vertex™ Deck	\$419.00
4RAMPTGD	4' Shoreside Pivot Ramp - Tan Glacier Deck	\$429.00
4RAMPGGD	4' Shoreside Pivot Ramp - Gray Glacier Deck	\$429.00

#### 8' LONG SHORESIDE PIVOT RAMP

8RAMPRC	8' Shoreside Pivot Ramp - Premium Cedar Deck	\$629.00
8RAMPIE	8' Shoreside Pivot Ramp - Hardwood IPE Deck	\$1,429.00
8RAMPAL	8' Shoreside Pivot Ramp - Plain Aluminum Deck	\$799.00
8RAMPPA	8' Shoreside Pivot Ramp - White Aluminum Deck	\$999.00
8RAMPTP	8' Shoreside Pivot Ramp - Tan Aluminum Deck	\$999.00
8RAMPWG	8' Shoreside Pivot Ramp - Traditional Woodgrain Aluminum Deck	\$1,029.00
8RAMPGOWG	8' Shoreside Pivot Ramp - Gray Oak Woodgrain Aluminum Deck	\$1,029.00
8RAMPV	8' Shoreside Pivot Ramp - Vertex™ Deck	\$859.00
8RAMPTGD	8' Shoreside Pivot Ramp - Tan Glacier Deck	\$869.00
8RAMPGGD	8' Shoreside Pivot Ramp - Gray Glacier Deck	\$869.00

#### RS4 RAMP CONNECTOR

RS4RC	RS4 Ramp Connector	\$172.00
-------	--------------------	----------

#### CORNER DOCK SECTIONS

CDSRC	Corner Dock Section - Premium Cedar Deck	\$299.00
CDSIPE	Corner Dock Section - Hardwood IPE Deck	\$499.00
CDSAL	Corner Dock Section - Plain Aluminum Deck	\$339.00
CDSPA	Corner Dock Section - White Aluminum Deck	\$399.00
CDSTP	Corner Dock Section - Tan Aluminum Deck	\$399.00
CDSWG	Corner Dock Section - Traditional Woodgrain Aluminum Deck	\$439.00
CDSGOWG	Corner Dock Section - Gray Oak Woodgrain Aluminum Deck	\$439.00
CDSV	Corner Dock Section - Vertex™ Deck	\$409.00
CDSTGD	Corner Dock Section - Tan Glacier Deck	\$439.00
CDSGGD	Corner Dock Section - Gray Glacier Deck	\$439.00



## options

### LAKEVIEW DOCK BENCH

With QuickConnect™, you can mount this bench anywhere on the dock. Add the optional armrest with beverage holder for extra comfort.

### SHORESIDE PIVOT RAMP

Access your dock with ease with the 4' or 8' shoreside pivot ramp. Available with a variety of options to match your deck.

### CORNER DOCK SECTIONS

Added safety for kids and adults, it also adds stability to dock system.

### QUICKCONNECT™ FLAGPOLE HOLDER

Attaches to any QuickConnect™ bracket and accepts poles up to 2.5" in diameter.

### QUICKCONNECT™ CANOE, KAYAK, AND PADDLEBOARD RACK

Attach the Canoe, Kayak and Paddleboard Rack with the QuickConnect™ System for easy installation.

### UNI-HANDRAIL

Add safety to your Infinity RS4 dock with easy attachment to the side of the dock.

# INFINITY RS4 DOCK

## CURVED DOCK AND ACCESSORIES

### MODELS AND SPECIFICATIONS

#### 4' X 4' RS4 DOCK SECTION

		NET PRICE
44RCD	4' x 4' Dock - Premium Cedar Deck	\$549.00
44IPED	4' x 4' Dock - Hardwood IPE Deck	\$899.00
44ALD	4' x 4' Dock - Plain Aluminum Deck	\$619.00
44PED	4' x 4' Dock - White Aluminum Deck	\$759.00
44TPD	4' x 4' Dock - Tan Aluminum Deck	\$759.00
44WGD	4' x 4' Dock - Traditional Woodgrain Aluminum Deck	\$779.00
44GOWGD	4' x 4' Dock - Gray Oak Woodgrain Aluminum Deck	\$779.00
44VD	4' x 4' Dock - Vertex™ Deck	\$699.00
44TGD	4' x 4' Dock - Tan Glacier Deck	\$719.00
44GGD	4' x 4' Dock - Gray Glacier Deck	\$719.00

(INCLUDES 2 INFINITY SINGLE LEG POCKETS, 2 FOOT PADS, 1 HARDWARE BAG, REMOVABLE PANEL IS 42" X 45" WHICH IS SMALLER THAN STANDARD PANEL SIZE)

#### 45 DEGREE RS4 DOCK SECTION

45CURVERC	45 Degree Curve Dock - Premium Cedar Deck	\$439.00
45CURVEIPE	45 Degree Curve Dock - Hardwood IPE Deck	\$789.00
45CURVEAD	45 Degree Curve Dock - Plain Aluminum Deck	\$529.00
45CURVEPA	45 Degree Curve Dock - White Aluminum Deck	\$589.00
45CURVETP	45 Degree Curve Dock - Tan Aluminum Deck	\$589.00
45CURVEWG	45 Degree Curve Dock - Traditional Woodgrain Aluminum Deck	\$619.00
45CURVEGOWG	45 Degree Curve Dock - Gray Oak Woodgrain Aluminum Deck	\$619.00
45CURVEV	45 Degree Curve Dock - Vertex™ Deck	\$609.00
45CURVETGD	45 Degree Curve Dock - Tan Glacier Deck	\$599.00
45CURVEGGD	45 Degree Curve Dock - Gray Glacier Deck	\$599.00

#### 90 DEGREE RS4 DOCK SECTION

90CURVERC	90 Degree Curve Dock - Premium Cedar Deck	\$459.00
90CURVEIPE	90 Degree Curve Dock - Hardwood IPE Deck	\$899.00
90CURVEAD	90 Degree Curve Dock - Plain Aluminum Deck	\$539.00
90CURVEPA	90 Degree Curve Dock - White Aluminum Deck	\$589.00
90CURVETP	90 Degree Curve Dock - Tan Aluminum Deck	\$589.00
90CURVEWG	90 Degree Curve Dock - Traditional Woodgrain Aluminum Deck	\$619.00
90CURVEGOWG	90 Degree Curve Dock - Gray Oak Woodgrain Aluminum Deck	\$619.00
90CURVEV	90 Degree Curve Dock - Vertex™ Deck	\$599.00
90CURVETGD	90 Degree Curve Dock - Tan Glacier Deck	\$609.00
90CURVEGGD	90 Degree Curve Dock - Gray Glacier Deck	\$609.00

#### CURVED DECK LEG ACCESSORIES

SALP90	90 Degree Single Leg Pocket	\$84.00
DALP45	45 Degree Double Leg Pocket	\$115.00



### TURN YOUR INFINITY RS4 DOCK INTO SOMETHING TRULY UNIQUE.

To get a new twist on waterfront fun, throw a curve or two into your dock. With our curved sections, you can create all kinds of exciting new shapes, directions and even round platforms. With the same decking options as the Infinity RS4 Dock, these curves fit right in.



#### 1/4 ROUND - 90 DEGREE

Put your imagination to the test for all sorts of interesting possibilities.



#### 1/8 ROUND - 45 DEGREE

Like our 1/4 round sections, you can use 1/8 rounds with other curved or standard RS4 sections. Just imagine the fun you'll have when you get eight together for a 12' diameter platform.



# INFINITY RS7 DOCK

STRONG. SOLID. HIGHLY CONFIGURABLE.



**ENDLESS CONFIGURATIONS**  
for virtually unlimited layouts or designs.



## benefits

### REMARKABLE STRENGTH

Industry leading 6.75" side rails provide remarkable strength and durability.

### EASY CUSTOMIZATION

The QuickConnect™ accessory system makes it easy to install and remove accessories without tools.

### EASY HEIGHT ADJUSTMENT

Screw legs allow you to easily adjust your dock height in minutes without getting in the water.

### PREMIUM STABILITY

5-Sided Dock Legs™ provide three points of contact for unmatched dock stability and safety.

### THE MOST DECKING OPTIONS

Achieve your desired look by choosing from ShoreMaster's 8 premium decking options including Cedar, Vertex™, Aluminum and more.

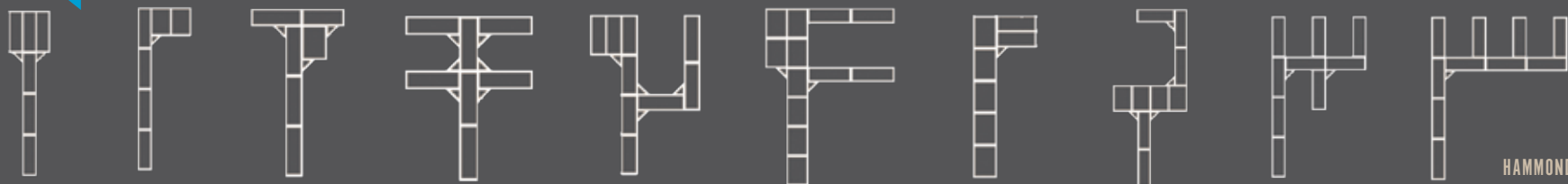

# INFINITY RS7 DOCK

## DOCK AND ACCESSORIES

### MODELS AND SPECIFICATIONS

4' X 8' RS7 DOCK		NET PRICE
48RCD	4' x 8' Dock - Premium Cedar Deck	\$849.00
48IPED	4' x 8' Dock - Hardwood IPE Deck	\$1,599.00
48AD	4' x 8' Dock - Plain Aluminum Deck	\$959.00
48PED	4' x 8' Dock - White Aluminum Deck	\$1,079.00
48TPD	4' x 8' Dock - Tan Aluminum Deck	\$1,079.00
48WGD	4' x 8' Dock - Traditional Woodgrain Aluminum Deck	\$1,129.00
48GOWGD	4' x 8' Dock - Gray Oak Woodgrain Aluminum Deck	\$1,129.00
48VD	4' x 8' Dock - Vertex™ Deck	\$989.00
48TGD	4' x 8' Dock - Tan Glacier Deck	\$1,029.00
48GGD	4' x 8' Dock - Gray Glacier Deck	\$1,029.00
4' X 16' RS7 DOCK		
416RCD	4' x 16' Dock - Premium Cedar Deck	\$1,429.00
416IPED	4' x 16' Dock - Hardwood IPE Deck	\$2,799.00
416AD	4' x 16' Dock - Plain Aluminum Deck	\$1,599.00
416PED	4' x 16' Dock - White Aluminum Deck	\$1,929.00
416TPD	4' x 16' Dock - Tan Aluminum Deck	\$1,929.00
416WGD	4' x 16' Dock - Traditional Woodgrain Aluminum Deck	\$1,949.00
416GOWGD	4' x 16' Dock - Gray Oak Woodgrain Aluminum Deck	\$1,949.00
416VD	4' x 16' Dock - Vertex™ Deck	\$1,769.00
416TGD	4' x 16' Dock - Tan Glacier Deck	\$1,829.00
416GGD	4' x 16' Dock - Gray Glacier Deck	\$1,829.00
RS7 CORNER SECTIONS		
RS7CDSRC	Corner Section - Premium Cedar Deck	\$329.00
RS7CDSIPE	Corner Section - Hardwood IPE Deck	\$499.00
RS7CDSAL	Corner Section - Plain Aluminum Deck	\$369.00
RS7CDSPA	Corner Section - White Aluminum Deck	\$409.00
RS7CDSTP	Corner Section - Tan Aluminum Deck	\$409.00
RS7CDSWG	Corner Section - Traditional Woodgrain Aluminum Deck	\$449.00
RS7CDSGOWG	Corner Section - Gray Oak Woodgrain Aluminum Deck	\$449.00
RS7CDSV	Corner Section - Vertex™ Deck	\$419.00
RS7CDSTGD	Corner Section - Tan Glacier Deck	\$449.00
RS7CDSGGD	Corner Section - Gray Glacier Deck	\$449.00



## options

### QUICKCONNECT™ PIVOT LADDER

Crafted with alloy aluminum construction and available in 3, 4 and 5-step, the QuickConnect™ Pivot Ladder will enhance the use of your waterfront.



### QUICKCONNECT™ ROPE CLEAT

Provides a convenient tie-up for visiting boats and can be positioned anywhere along your dock. Utilizes the QuickConnect™ System and no drilling required.



### CORNER DOCK SECTIONS

Added safety for kids and adults, it also adds stability to dock system.

# INFINITY RS7 DOCK

## DOCK ACCESSORIES

### MODELS AND SPECIFICATIONS

#### DOCK LEG POSTS

		NET PRICE
3LEGP	3' Dock Leg Post (EACH)	\$55.00
5LEGP	5' Dock Leg Post (EACH)	\$79.00
7LEGP	7' Dock Leg Post (EACH) <sup>†</sup>	\$99.00
9LEGP	9' Dock Leg Post (EACH) <sup>†</sup>	\$131.00
12LEGP	12' Dock Leg Post (EACH) <sup>†</sup>	\$177.00

#### DOCK LADDERS

3LADQC	3 Step QuickConnect™ Ladder** (34" FROM TOP OF DOCK TO BOTTOM OF LADDER)	\$289.00
4LADQC	4 Step QuickConnect™ Ladder** (46" FROM TOP OF DOCK TO BOTTOM OF LADDER)	\$339.00
5LADQC	5 Step QuickConnect™ Ladder** (58" FROM TOP OF DOCK TO BOTTOM OF LADDER)	\$399.00

#### DOCK STEPS WITH HANDRAIL

4DOCKSTEPS	4 Dock Steps with Handrail** (ADJUSTS FROM 31" TO 43" - TOP OF DOCK TO BOTTOM OF LAKE)	\$529.00
6DOCKSTEPS	6 Dock Steps with Handrail** (ADJUSTS FROM 45" TO 57" - TOP OF DOCK TO BOTTOM OF LAKE)	\$629.00

#### DOCK LEG ACCESSORIES

UNIDWBPAIR	Diagonal Deep Water Brace (PAIR)	\$185.00
ISLP	Infinity Single Leg Pocket	\$85.00
HEAVYDWB	4' Heavy Duty Deep Water Brace (EACH)	\$208.00
SHORTSALP	Short Single Adjustable Leg Pocket (EACH)	\$54.00
AFP	Adjustable Foot Pad (EACH)	\$51.00

#### DOCK BUMPERS

1ODB	10' Dockside Bumper (EACH)	\$69.00
CDB	Rhino Corner Bumper - Blue (EACH)	\$39.00
VDB	QuickConnect™ Vertical Dock Bumper*	\$124.00
QVCDB	QuickConnect™ Vertical Corner Bumper	\$259.00
VDBHA	Vertical Dock Bumper Horizontal Adapter	\$18.00



## options

### DIAGONAL DEEP WATER BRACE

The easy installation will add support to your dock increasing its stability. For deep water applications (5' or greater).

### DOCK STEPS WITH HANDRAIL

For swimming and safety, ShoreMaster steps are essential. They are available in 4 and 6-step versions and feature marine alloy aluminum construction with stainless steel hardware. Made to fit most styles of stationary dock and wheel-in dock.

### QUICKCONNECT™ VERTICAL DOCK BUMPER

Provide additional protection for your boat & swimmers. The QuickConnect™ Vertical Dock Bumper is aluminum channeled with a vinyl surface and adjustable to help prevent your boat from going over or under your dock.

<sup>†</sup>REQUIRES USE OF DIAGONAL DEEP WATER BRACE.

\*REQUIRES 1 EACH QUICKCONNECT™ ACCESSORY BRACKET. \*\*REQUIRES 2 EACH QUICKCONNECT™ ACCESSORY BRACKETS.

# INFINITY RS7 DOCK

## DOCK ACCESSORIES

### MODELS AND SPECIFICATIONS

#### RS7 ADJUSTABLE SCREW LEGS

		NET PRICE
ASLWSS	Super Shallow Water (26"-36") Screw Leg with Wheel (EACH)	\$299.00
ASLWSHAL	Shallow Water (37"-57") Screw Leg with Wheel (EACH)	\$309.00
ASLWSTD	Standard Water (48"-72") Screw Leg with Wheel (EACH)	\$349.00
ASLWDEEP	Deep Water (66"-105") Screw Leg with Wheel (EACH)	\$439.00

Measurement from bottom of tire (lake bottom) to bottom of side rail.

#### RS7 ACCESSORIES

QCRC	QuickConnect™ Rope Cleat	\$33.00
TOW	QuickConnect™ Tow Hitch	\$299.00
QCSEWK	QuickConnect™ Shore End Wheel Kit (2X2 LEGS PURCHASED SEPARATELY)	\$315.00
DAQCSLSDC	Deep Water Screw Leg Cross Tube (REQUIRED FOR 4' WIDE RS7 WITH DEEP WATER SCREW LEGS)	\$25.00
RS7DBLLBRACE	RS7 Double L Brace (PAIR)	\$347.00
DBLKAYAKKIT	Double Kayak Kit (MUST PURCHASE CANOE RACK SEPARATELY)	\$149.00
TLBQC	QuickConnect™ Lakeview Bench**	\$349.00
LVARM	Arm Rest for Lakeview Bench	\$149.00
CANOERACK	QuickConnect™ Canoe, Kayak, Paddleboard Rack**	\$249.00
FRHOLDER	Fishing Rod Holder*	\$59.00
UNIHANDRAIL	10' QuickConnect™ Hand Rail***	\$339.00
QC8HR	8' QuickConnect™ Hand Rail**	\$289.00
QC6HR	6' QuickConnect™ Hand Rail**	\$199.00
QC4HR	4' QuickConnect™ Hand Rail**	\$169.00
SUPBR	QuickConnect™ Dual Stand-Up Paddleboard Rack**	\$529.00
SDLSPW	LED White Solar Powered Dock Light (PAIR)	\$59.00
FURNITURE	QuickConnect™ Dock Furniture (2 CHAIRS, TABLE AND UMBRELLA)***	\$925.00

#### QUICKCONNECT™ ACCESSORY BRACKET

RS7QCBR	RS7 QuickConnect™ Accessory Bracket	\$39.00
---------	-------------------------------------	---------

#### QUICKCONNECT™ QUICK STEPS

QUICKSTEPS4	4-Step Quick Steps with handrails	\$1,199.00
QUICKSTEPS6	6-Step Quick Steps with handrails	\$1,399.00
QSRS4CB	Infinity RS4 Quick Step Bracket	\$129.00
QSRS7CB	Infinity RS7 Quick Step Bracket	\$129.00
QSTS9CB	Infinity TS9 Quick Step Bracket	\$129.00
QSUNIGB	Quick Steps QuickConnect™ Universal Bracket	\$129.00
QSSK	Quick Steps Splice Kit	\$89.00



## options

### 24" POLY TIRES

Our Poly Tires are self-draining to reduce weight when removing your dock from the water and to make off-season storage quick and easy. With rigid sidewalls, they won't deflate.



### QUICKCONNECT™ SYSTEM

Allows for easy, no-tool attachment and movement of accessories, including off deck benches, vertical bumpers, steps and more.



### QUICKCONNECT QUICK STEPS

Quick Steps provide safe, stable access to the water. A wider width & step tread means more stability at the waterfront, and are available in 4 or 6-steps.



### QUICKCONNECT™ TOW HITCH

Convenient hitch hooks up to your tow vehicle for easy installation and removal.



### QUICKCONNECT™ DOCK FURNITURE

Relax on your dock in style. The QuickConnect™ Dock Furniture comes with 2 chairs, a table, and an umbrella.

\*REQUIRES 1 EACH QUICKCONNECT™ ACCESSORY BRACKETS.

\*\*REQUIRES 2 EACH QUICKCONNECT™ ACCESSORY BRACKETS. \*\*\*REQUIRES 3 EACH QUICKCONNECT™ ACCESSORY BRACKETS.



# INFINITY RS7 DOCK

## DOCK ACCESSORIES

### MODELS AND SPECIFICATIONS

#### 4' LONG SHORESIDE PIVOT RAMP

		NET PRICE
4RAMPRC	4' Shoreside Pivot Ramp - Premium Cedar Deck	\$329.00
4RAMPIPE	4' Shoreside Pivot Ramp - Hardwood IPE	\$759.00
4RAMPAL	4' Shoreside Pivot Ramp - Plain Aluminum Deck	\$399.00
4RAMPPA	4' Shoreside Pivot Ramp - White Aluminum Deck	\$529.00
4RAMPTP	4' Shoreside Pivot Ramp - Tan Aluminum Deck	\$529.00
4RAMPWG	4' Shoreside Pivot Ramp - Traditional Woodgrain Aluminum Deck	\$539.00
4RAMPGWG	4' Shoreside Pivot Ramp - Gray Oak Woodgrain Aluminum Deck	\$539.00
4RAMPV	4' Shoreside Pivot Ramp - Vertex™ Deck	\$419.00
4RAMPTGD	4' Shoreside Pivot Ramp - Tan Glacier Deck	\$429.00
4RAMPGGD	4' Shoreside Pivot Ramp - Gray Glacier Deck	\$429.00

#### 8' LONG SHORESIDE PIVOT RAMP

8RAMPRC	8' Shoreside Pivot Ramp - Premium Cedar Deck	\$629.00
8RAMPIPE	8' Shoreside Pivot Ramp - Hardwood IPE	\$1,429.00
8RAMPAL	8' Shoreside Pivot Ramp - Plain Aluminum Deck	\$799.00
8RAMPPA	8' Shoreside Pivot Ramp - White Aluminum Deck	\$999.00
8RAMPTP	8' Shoreside Pivot Ramp - Tan Aluminum Deck	\$999.00
8RAMPWG	8' Shoreside Pivot Ramp - Traditional Woodgrain Aluminum Deck	\$1,029.00
8RAMPGWG	8' Shoreside Pivot Ramp - Gray Oak Woodgrain Aluminum Deck	\$1,029.00
8RAMPV	8' Shoreside Pivot Ramp - Vertex™ Deck	\$859.00
8RAMPTGD	8' Shoreside Pivot Ramp - Tan Glacier Deck	\$869.00
8RAMPGGD	8' Shoreside Pivot Ramp - Gray Glacier Deck	\$869.00

#### RS7 RAMP CONNECTOR

RS7RC	RS7 Ramp Connector	\$179.00
-------	--------------------	----------



## options

### SHORESIDE PIVOT RAMP

Access your dock with ease with the 4' or 8' shoreside pivot ramp. Available with a variety of options to match your deck.

### QUICKCONNECT™ LAKEVIEW BENCH

With the QuickConnect™ System, you can mount this bench anywhere on the dock. Add the optional armrest with beverage holder for extra comfort.

### QUICKCONNECT™ CANOE & KAYAK RACK

Attach the Canoe & Kayak Rack with the QuickConnect™ System for easy installation.

# QUICKCONNECT™ QUICK STEPS

EASY INSTALLATION. VERSATILE APPLICATION. ALL TERRAIN FUNCTIONALITY.

## UNMATCHED VERSATILITY

Connect to your dock, using the included foot pads or simply pound leg posts into the ground. No matter your installation site the Quick Steps easily provide safe, stable access to the water.

## PREMIUM PERFORMANCE

All aluminum construction, along with stainless steel and brass hardware, means our Quick Steps are corrosion and rust resistant, yet lightweight and easily assembled. Enjoy stable, premium performance for years to come.

## WIDER WIDTH AND STEP TREAD

A wider width and step tread means more stability at the waterfront.  
Stairway Opening Width - 33.75"  
Overall Width - 41"  
Step Tread Depth - 7.125"

## 4- OR 6-STEP OPTION

Available as a 4-Step or 6-Step section, or use the connection kit to extend as needed (see insert).

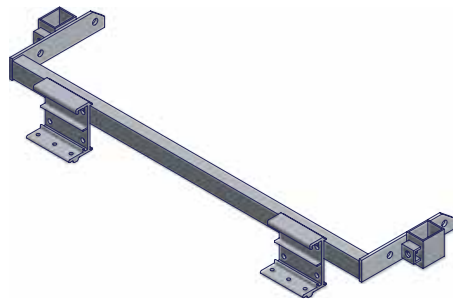

## QUICKCONNECT™ INSTALLATION

Easily connect to ShoreMaster's Infinity series (RS4, RS7, or TS9) dock sections using the QuickConnect Bracket. ShoreMaster's exclusive QuickConnect system means quick assembly and tool free installation.

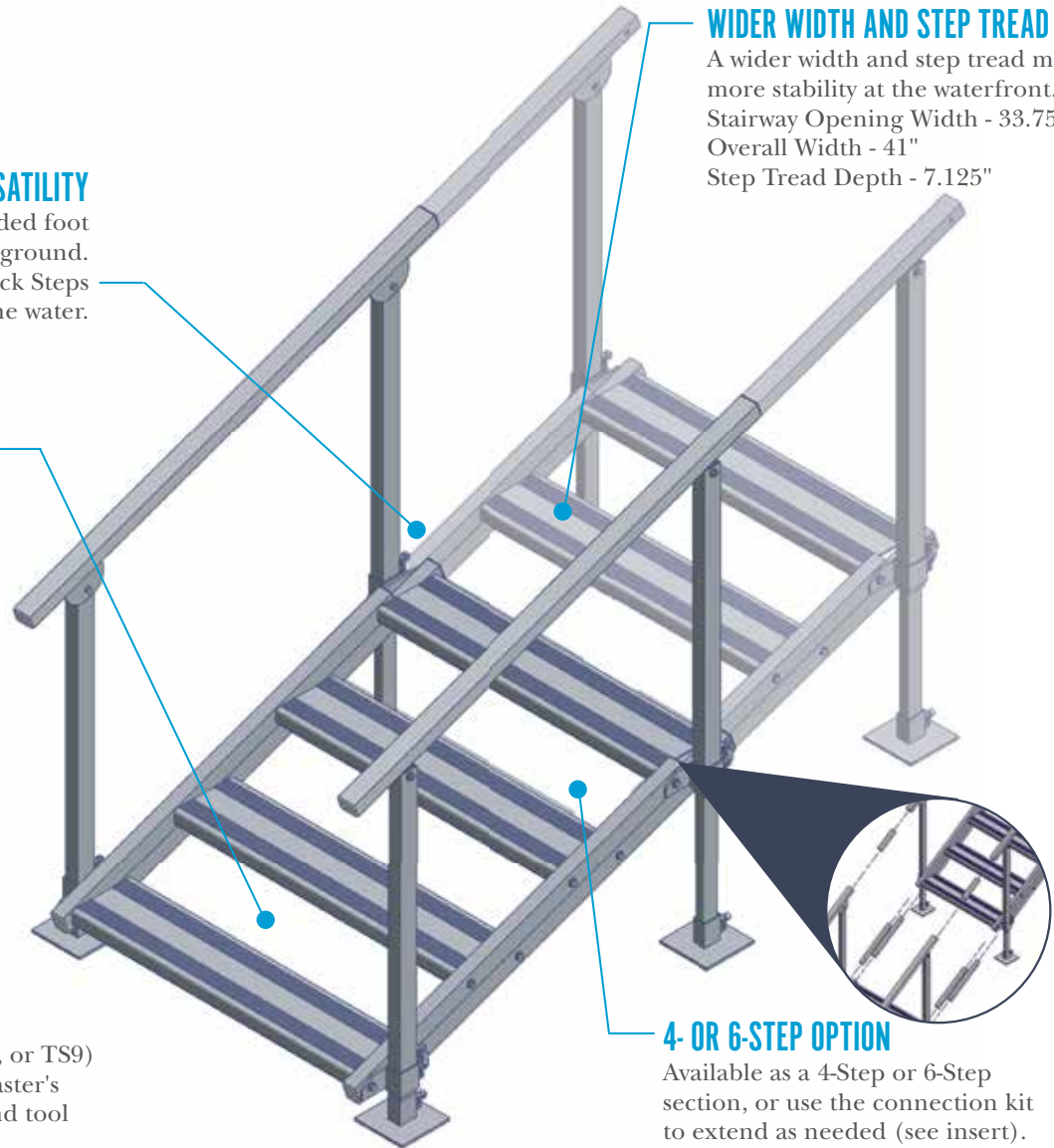

# QUICKCONNECT™ QUICK STEPS

THE MOST FUNCTIONAL, EASIEST TO USE DOCK STEPS AVAILABLE.

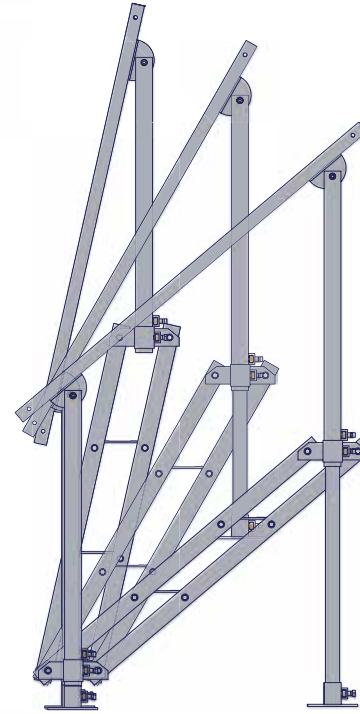

## ENDLESS VERSATILITY AND EASY CONNECTIONS

Dock steps. Landscaping steps. The possibilities are endless with ShoreMaster all-terrain QC Quick Steps. Connect multiple sets of steps together easily for seamless access no matter the length or distance

## MODELS

### QUICKCONNECT™ QUICK STEPS

### NET PRICE

QUICKSTEPS4	4-Step Quick Steps with handrails	\$1,199.00
QUICKSTEPS6	6-Step Quick Steps with handrails	\$1,399.00
QSRS4CB	Infinity RS4 Quick Step Bracket	\$129.00
QSRS7CB	Infinity RS7 Quick Step Bracket	\$129.00
QSTS9CB	Infinity TS9 Quick Step Bracket	\$129.00
QSUNICB	Quick Steps QuickConnect™ Universal Bracket	\$129.00
QSSK	Quick Steps Splice Kit	\$89.00

## SETS AND SPECIFICATIONS

### 4 STEP SET    20° INCLINE    45° INCLINE    60° INCLINE

OVERALL LENGTH	46"	44-1/2"	43"
STEP HEIGHT	4-1/2"	9-1/4"	11-1/4"
STEP DISTANCE	12-1/4"	9-1/4"	6-1/2"

### 6 STEP SET    20° INCLINE    45° INCLINE    60° INCLINE

OVERALL LENGTH	72"	70-1/2"	69"
STEP HEIGHT	4-1/2"	9-1/4"	11-1/4"
STEP DISTANCE	12-1/4"	9-1/4"	6-1/2"

(NOTE: EACH SPLICE KIT WILL ADD 13" TO THE OVERALL LENGTH OF THE SET OF STAIRS. THE DOCK CONNECTOR WILL ADD APPROX. 3" TO THE LENGTH OF THE SET OF STAIRS)

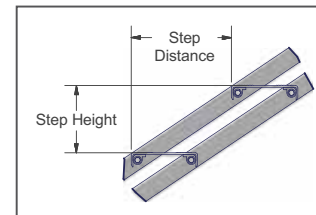
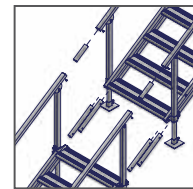

## QUICKCONNECT INSTALLATION

ShoreMaster's exclusive QuickConnect™ system means quick, easy assembly and tool-free installation.

## ADJUSTABLE SLOPE

Install as ascending or descending unit with a pivoting hinge design allows for adaptability to nearly any slope.

# QUICKCONNECT™ HINGES

## MODELS AND SPECIFICATIONS

HINGES		NET PRICE
RS4ASH	Infinity RS4/Gangway 4' "A" Side (HINGE ONLY)	\$91.00
RS4BSH	Infinity RS4/Gangway 4' "B" Side (HINGE ONLY)	\$95.00
RS7ASH	Infinity RS7 4' "A" Side (HINGE ONLY)	\$129.00
RS7BSH	Infinity RS7 4' "B" Side (HINGE ONLY)	\$135.00
TS9ASH	Infinity TS9 4' "A" Side (HINGE ONLY)	\$114.00
TS9BSH	Infinity TS9 4' "B" Side (HINGE ONLY)	\$104.00
PDSA	PolyDock 4' "A" Side (HINGE ONLY)	\$101.00
PDSB	PolyDock 4' "B" Side (HINGE ONLY)	\$109.00
SWBSH	Seawall 4' "B" Side - Angle (HINGE ONLY)	\$141.00
NSMASH	Non-Shoremaster 4' "A" Side (HINGE ONLY)	\$132.50
NSMBSH	Non-Shoremaster 4' "B" Side (HINGE ONLY)	\$115.50

## BOLT BAGS

AH2BHBB	RS4/RS6/TS9 "A" Hinge to RS4/RS7/TS9 "B" Hinge (BOLT BAG ONLY)	\$74.00
AH2PDHBB	RS4/RS7/TS9 "A" Hinge to PolyDock Hinge (BOLT BAG ONLY)	\$114.00
NSMHBB	Non-Shoremaster Hinge (BOLT BAG ONLY)	\$47.00

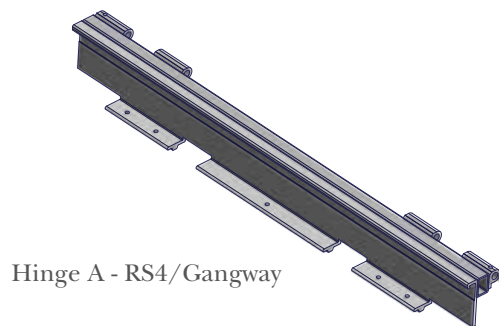

Hinge A - RS4/Gangway

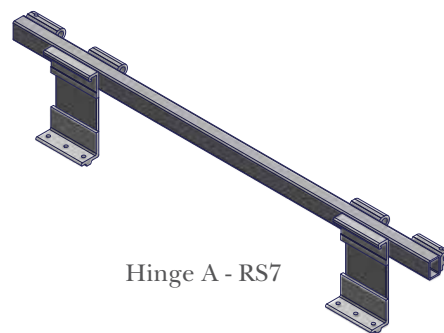

Hinge A - RS7



Hinge B - 4' NSMBSH

## FLEXIBLE VERSATILITY

Connect dock sections, ramps, floating dock sections, sea walls and ramps. QC Hinges are available in a variety of options.

## QUICKCONNECT INSTALLATION

ShoreMaster's exclusive QuickConnect™ system means quick, easy assembly and stress-free installation.

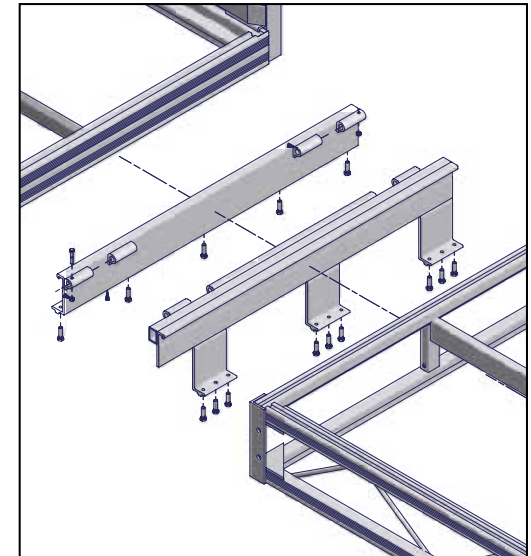

# GANGWAYS

## EASY ACCESS TO YOUR DOCK.



### MODELS AND SPECIFICATIONS

#### 16' GANGWAYS

		NET PRICE
416GANGRC	4' x 16' Gangway with Handrails - Premium Cedar Deck	\$2,629.00
416GANGIPED	4' x 16' Gangway with Handrails - Hardwood IPE Deck	\$3,999.00
416GANGAD	4' x 16' Gangway with Handrails - Plain Aluminum Deck	\$2,899.00
416GANGPED	4' x 16' Gangway with Handrails - White Aluminum Deck	\$3,169.00
416GANGTPD	4' x 16' Gangway with Handrails - Tan Aluminum Deck	\$3,169.00
416GANGWG	4' x 16' Gangway with Handrails - Traditional Woodgrain Aluminum Deck	\$3,249.00
416GANGGOWG	4' x 16' Gangway with Handrails - Gray Oak Woodgrain Aluminum Deck	\$3,249.00
416GANGVD	4' x 16' Gangway with Handrails - Vertex™ Deck	\$2,989.00
416GANGTGD	4' x 16' Gangway with Handrails - Tan Glacier Deck	\$3,049.00
416GANGGGD	4' x 16' Gangway with Handrails - Gray Glacier Deck	\$3,049.00

#### 20' GANGWAYS

420GANGRC	4' x 20' Gangway with Handrails - Premium Cedar Deck	\$3,399.00
420GANGIPED	4' x 20' Gangway with Handrails - Hardwood IPE Deck	\$5,199.00
420GANGAD	4' x 20' Gangway with Handrails - Plain Aluminum Deck	\$3,859.00
420GANGPED	4' x 20' Gangway with Handrails - White Aluminum Deck	\$4,179.00
420GANGTPD	4' x 20' Gangway with Handrails - Tan Aluminum Deck	\$4,179.00
420GANGWG	4' x 20' Gangway with Handrails - Traditional Woodgrain Aluminum Deck	\$4,269.00
420GANGGOWG	4' x 20' Gangway with Handrails - Gray Oak Woodgrain Aluminum Deck	\$4,269.00
420GANGVD	4' x 20' Gangway with Handrails - Vertex™ Deck	\$3,999.00
420GANGTGD	4' x 20' Gangway with Handrails - Tan Glacier Deck	\$4,199.00
420GANGGGD	4' x 20' Gangway with Handrails - Gray Glacier Deck	\$4,199.00

#### 24' GANGWAYS

424GANGRC	4' x 24' Gangway with Handrails - Premium Cedar Deck	\$3,929.00
424GANGIPED	4' x 24' Gangway with Handrails - Hardwood IPE Deck	\$5,999.00
424GANGAD	4' x 24' Gangway with Handrails - Plain Aluminum Deck	\$4,349.00
424GANGPED	4' x 24' Gangway with Handrails - White Aluminum Deck	\$4,899.00
424GANGTPD	4' x 24' Gangway with Handrails - Tan Aluminum Deck	\$4,899.00
424GANGWG	4' x 24' Gangway with Handrails - Traditional Woodgrain Aluminum Deck	\$5,199.00
424GANGGOWG	4' x 24' Gangway with Handrails - Gray Oak Woodgrain Aluminum Deck	\$5,199.00
424GANGVD	4' x 24' Gangway with Handrails - Vertex™ Deck	\$4,499.00
424GANGTGD	4' x 24' Gangway with Handrails - Tan Glacier Deck	\$4,599.00
424GANGGGD	4' x 24' Gangway with Handrails - Gray Glacier Deck	\$4,599.00

#### GANGWAY ACCESSORIES

ROLLER	Gangway Bolt-on Roller Kit	\$166.00
SUPFLOAT	Supplemental Float Cradle with Float****	\$496.00

#### QUICKCONNECT™ ACCESSORY BRACKET

RS4QCBR	RS4 QuickConnect™ Accessory Bracket	\$36.00
---------	-------------------------------------	---------

### EASY ACCESS TO YOUR DOCK.

Access your dock with ShoreMaster residential Gangways. It's a perfect solution to your unique shoreline. Available in 4' width and 16', 20', and 24' lengths. As part of the Gangway structure, the handrail provides strength and safety. Available with eight deck options to match your dock installation. A variety of connection options available.



PLAIN ALUMINUM

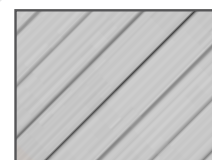

TAN ALUMINUM



WHITE ALUMINUM

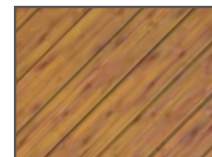

TRADITIONAL OAK

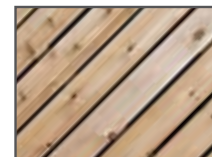

PREMIUM CEDAR

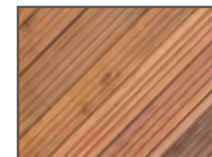

HARDWOOD IPE



GLACIER



VERTEX™

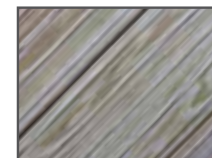

GRAY OAK

\*\*\*\*REQUIRES 4 EACH QUICKCONNECT™ ACCESSORY BRACKETS.



# INFINITY TS9 DOCK

AVAILABLE AS A STANDING DOCK OR WHEEL-IN



**ENDLESS CONFIGURATIONS**  
for virtually unlimited  
layouts or designs.



## *benefits*

### PREMIUM STABILITY

5-Sided Dock Legs™ provide three points of contact for unmatched dock stability and safety.

### REMARKABLE STRENGTH

9" classic truss sides and welded aluminum frame provide superior strength and timeless durability.

### EASY CUSTOMIZATION

The QuickConnect™ accessory system makes it easy to install and remove accessories without tools.

### THE MOST DECKING OPTIONS

Achieve your desired look by choosing from 8 premium decking options including Hardwood IPE, Painted Aluminum and more.

# INFINITY TS9 DOCK

## DOCK AND ACCESSORIES

### MODELS AND SPECIFICATIONS

#### 4' X 8' TS9 DOCK

		NET PRICE
48TS9RCD	4' x 8' Dock - Premium Cedar Deck <sup>†</sup>	\$899.00
48TS9IPED	4' x 8' Dock - Hardwood IPE Deck <sup>†</sup>	\$1,699.00
48TS9AD	4' x 8' Dock - Plain Aluminum Deck <sup>†</sup>	\$1,029.00
48TS9PED	4' x 8' Dock - White Aluminum Deck <sup>†</sup>	\$1,129.00
48TS9TPD	4' x 8' Dock - Tan Aluminum Deck <sup>†</sup>	\$1,129.00
48TS9WGD	4' x 8' Dock - Traditional Woodgrain Aluminum Deck <sup>†</sup>	\$1,169.00
48TS9GOWGD	4' x 8' Dock - Gray Oak Woodgrain Aluminum Deck <sup>†</sup>	\$1,169.00
48TS9VD	4' x 8' Dock - Vertex™ Deck <sup>†</sup>	\$1,049.00
48TS9TGD	4' x 8' Dock - Tan Glacier Deck <sup>†</sup>	\$1,099.00
48TS9GGD	4' X 8' Dock - Gray Glacier Deck <sup>†</sup>	\$1099.00

#### 4' X 16' TS9 DOCK

416TS9RCD	4' x 16' Dock - Premium Cedar Deck <sup>†</sup>	\$1,499.00
416TS9IPED	4' x 16' Dock - Hardwood IPE Deck <sup>†</sup>	\$2,899.00
416TS9AD	4' x 16' Dock - Plain Aluminum Deck <sup>†</sup>	\$1,699.00
416TS9PED	4' x 16' Dock - White Aluminum Deck <sup>†</sup>	\$1,999.00
416TS9TPD	4' x 16' Dock - Tan Aluminum Deck <sup>†</sup>	\$1,999.00
416TS9WGD	4' x 16' Dock - Traditional Woodgrain Aluminum Deck <sup>†</sup>	\$2,049.00
416TS9GOWGD	4' x 16' Dock - Gray Oak Woodgrain Aluminum Deck <sup>†</sup>	\$2,049.00
416TS9VD	4' x 16' Dock - Vertex™ Deck <sup>†</sup>	\$1,829.00
416TS9TGD	4' x 16' Dock - Tan Glacier Deck <sup>†</sup>	\$1,889.00
416TS9GGD	4' X 16' Dock - Gray Glacier Deck <sup>†</sup>	\$1889.00

#### TS9 CORNER SECTIONS

FTS9CDSRC	Corner Section - Premium Cedar Deck	\$329.00
FTS9CDSIPE	Corner Section - Hardwood IPE Deck	\$529.00
FTS9CDSAL	Corner Section - Plain Aluminum Deck	\$399.00
FTS9CDSPA	Corner Section - White Aluminum Deck	\$429.00
FTS9CDSTP	Corner Section - Tan Aluminum Deck	\$429.00
FTS9CDSWG	Corner Section - Traditional Woodgrain Aluminum Deck	\$469.00
FTS9CDSGOWG	Corner Section - Gray Oak Woodgrain Aluminum Deck	\$469.00
FTS9CDSV	Corner Section - Vertex™ Deck	\$439.00
FTS9CDSTGD	Corner Section - Tan Glacier Deck	\$449.00
FTS9CDSGGD	Corner Section - Gray Glacier Deck	\$449.00

#### DOCK LEG POSTS

3LEGP	3' Dock Leg Post (EACH)	\$55.00
5LEGP	5' Dock Leg Post (EACH)	\$79.00
7LEGP	7' Dock Leg Post (EACH) <sup>†</sup>	\$99.00
9LEGP	9' Dock Leg Post (EACH) <sup>†</sup>	\$131.00
12LEGP	12' Dock Leg Post (EACH) <sup>†</sup>	\$177.00

## options

### QUICKCONNECT™ PIVOT LADDER

Crafted with alloy aluminum construction and available in 3, 4 and 5-step, the QuickConnect™ Pivot Ladder will enhance the use of your waterfront.



### QUICKCONNECT™ SYSTEM

Allows for easy, no-tool attachment and movement of accessories, including off deck benches, vertical bumpers, steps and more.



### QUICKCONNECT™ ROPE CLEAT

Provides a convenient tie-up for visiting boats and can be positioned anywhere along your dock. Utilizes the QuickConnect™ System and no drilling required.



### CORNER DOCK SECTIONS

Added safety for kids and adults, it also adds stability to dock system.



### DOCK LEG CAP

Add the finishing touch to your dock system and provide a soft feel and premium look. Available in gray to cover exposed leg pockets and blue for the top of exposed dock legs.





# INFINITY TS9 DOCK

## DOCK ACCESSORIES

### MODELS AND SPECIFICATIONS

#### DOCK LEG ACCESSORIES

		NET PRICE
UNIDWBPAIR	Diagonal Deep Water Brace (EACH)	\$185.00
ISLP	Infinity Single Leg Pocket	\$85.00
HEAVYDWB	4' Heavy Duty Deep Water Brace (EACH)	\$208.00
SHORTSALP	Short Single Adjustable Leg Pocket (EACH)	\$54.00
AFP	Adjustable Foot Pad (EACH)	\$51.00

#### TS9 ADJUSTABLE SCREW LEGS

ASLWSS	Super Shallow Water (26"-36") Screw Leg with Wheel (EACH)	\$289.00
ASLWSHAL	Shallow Water (37"-57") Screw Leg with Wheel (EACH)	\$299.00
ASLWSTD	Standard Water (48"-72") Screw Leg with Wheel (EACH)	\$349.00
ASLWDEEP	Deep Water (66"-105") Screw Leg with Wheel (EACH)	\$429.00

Measurement from bottom of tire (lake bottom) to bottom of side rail.

#### QUICKCONNECT™ QUICK STEPS

QUICKSTEPS4	4-Step Quick Steps with handrails	\$1,199.00
QUICKSTEPS6	6-Step Quick Steps with handrails	\$1,399.00
QSRS4CB	Infinity RS4 Quick Step Bracket	\$129.00
QSRS7CB	Infinity RS7 Quick Step Bracket	\$129.00
QSTS9CB	Infinity TS9 Quick Step Bracket	\$129.00
QSUNICB	Quick Steps QuickConnect™ Universal Bracket	\$129.00
QSSK	Quick Steps Splice Kit	\$89.00

#### DOCK LADDERS

3LADQC	3 Step QuickConnect™ Ladder** (34" FROM TOP OF DOCK TO BOTTOM OF LADDER)	\$289.00
4LADQC	4 Step QuickConnect™ Ladder** (46" FROM TOP OF DOCK TO BOTTOM OF LADDER)	\$339.00
5LADQC	5 Step QuickConnect™ Ladder** (58" FROM TOP OF DOCK TO BOTTOM OF LADDER)	\$399.00

#### QUICKCONNECT™ ACCESSORY BRACKET

TS9QCBBR	TS9 QuickConnect™ Accessory Bracket	\$39.00
----------	-------------------------------------	---------

#### DOCK STEPS WITH HANDRAIL

4DOCKSTEPS	4 Dock Steps with Handrail**	\$529.00
6DOCKSTEPS	6 Dock Steps with Handrail**	\$629.00



## options

### DIAGONAL DEEP WATER BRACE

The easy installation will add support to your dock increasing its stability. For deep water applications (5' or greater).

### DOCK STEPS WITH HANDRAIL

For swimming and safety, ShoreMaster steps are essential. They are available in 4 and 6-step versions and feature marine alloy aluminum construction with stainless steel hardware. Made to fit most styles of stationary dock and wheel-in dock.

### DOCK BUMPERS

Provide additional protection for your boat & swimmers. The QuickConnect™ Vertical Dock Bumper is aluminum channeled with a vinyl surface and adjustable to help prevent your boat from going over or under your dock.

### ADJUSTABLE SCREW LEGS WITH WHEELS

Adjust your dock to just the right height. Whether you are in deep or shallow waters, the TS9 will adjust to your life.

\*\*REQUIRES 2 EACH QUICKCONNECT™ ACCESSORY BRACKETS.



# FLOATING POLYDOCK

LOW MAINTENANCE. HIGHLY VERSATILE.

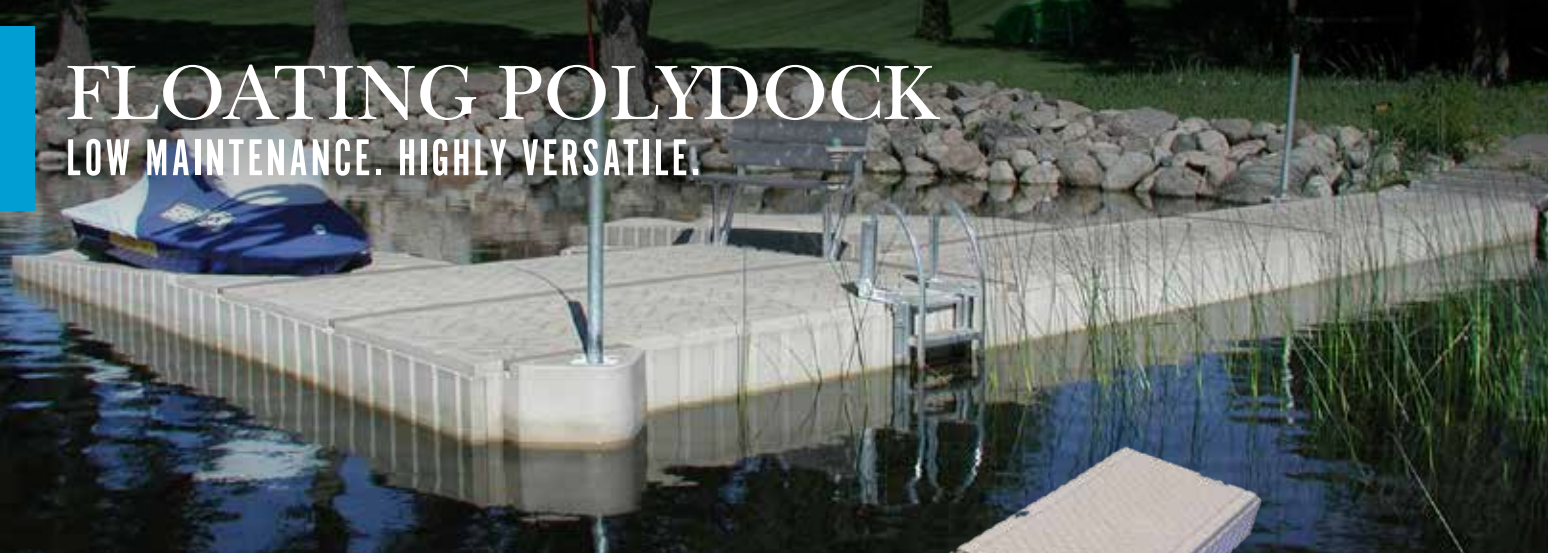

## ENDLESS CONFIGURATIONS

for virtually unlimited layouts or designs.

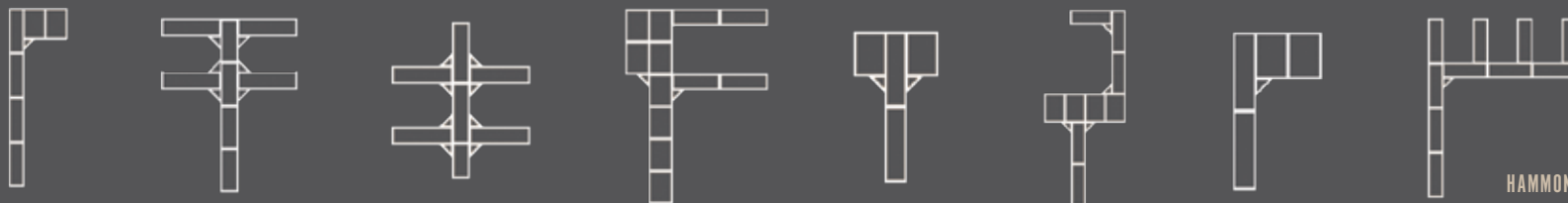

## *benefits*

### MODULAR DESIGN

The Floating PolyDock is highly customizable and has a modular design with unlimited versatility.

### SUPERIOR STRENGTH

Polyethylene single cavity, hollow, non-foam filled float structure that consists of an integrated deck surface and flotation.

### REMARKABLE STABILITY

The recessed areas on the bottom of each PolyDock section help to provide stability between the dock and the surface of the water.

### SHORELINE SUPPORT

Offering a variety of anchoring options to suit just about any shoreline.

### DECK SURFACE

The deck surface features a herringbone brick pattern. The spaces between each molded brick allow for water drainage from the deck surface.

# FLOATING POLYDOCK

## DOCK AND ACCESSORIES

### MODELS AND SPECIFICATIONS

FLOATING POLYDOCK		NET PRICE
46POLYDOCK	4' x 6' Floating PolyDock	\$799.00
310POLYDOCK	3' x 10' Floating PolyDock	\$939.00
POLYDOCK	4' x 10' Floating PolyDock	\$1,199.00
510POLYDOCK	5' x 10' Floating PolyDock	\$1,529.00
68POLYDOCK	6' x 8' Floating PolyDock	\$1,559.00
FLOATING POLYDOCK CORNER		
POLYCORNER	4' PolyDock Corner with Connectors	\$599.00
FLOATING POLYDOCK CONNECTORS AND BRACKETS		
3POLYCONN	3' PolyDock Connection	\$137.00
4POLYCONN	4' PolyDock Connection	\$206.00
5POLYCONN	5' PolyDock Connection	\$259.00
6POLYCONN	6' PolyDock Connection	\$297.00
8POLYCONN	8' PolyDock Double End Connector	\$422.00
10POLYCONN	10' PolyDock Connection	\$438.00
POLYPIPEBRA	PolyDock Pipe Bracket	\$231.00
SMALLPIPE	Light Duty Poly Pipe Bracket (TWO HALVES & BOLTS)	\$145.00
CHAINGUIDE	Chain Guide Bracket	\$351.00
8PILEHOOP	8" Pile Hoop for PolyDock	\$384.00
10PILE HOOP	10" Pile Hoop for PolyDock	\$391.00
12PILEHOOP	12" Pile Hoop for PolyDock	\$411.00
POLYLADCONN	Ladder Connection (DOES NOT INCLUDE LADDER)	\$137.00
POLYRAMPCONN	Ramp Connection (DOES NOT INCLUDE RAMP)	\$180.00
RAMPROLLER	Bolt On Roller Kit (TWO 6" ROLLERS TO ATTACH TO BOTTOM OF RAMP)	\$120.00
PDACCCN	6" Accessory Connection Plate	\$89.00
PD21GNP	21" Accessory Connection Plate	\$245.00
221GP	2" x 21' Galvanized Pipe (NO CUTTING)	\$199.00



## options

### QUICKCONNECT™ PIVOT LADDER

Crafted with alloy aluminum construction and available in 3, 4 and 5-step, the QuickConnect™ Pivot Ladder will enhance the use of your waterfront.

### FLOATING POLYDOCK CORNER

Featuring added safety for kids and adults, it also adds stability to dock system.

### PIPE BRACKET

Durable polyethylene pipe brackets keep your dock in place with changing water levels. It also adds stability.

## capacity

SIZE	CAPACITY	WEIGHT
4' x 6'	1,200 lbs	160 lbs
3' x 10'	1,360 lbs	200 lbs
4' x 10'	2,000 lbs	265 lbs
5' x 10'	2,300 lbs	340 lbs
6' x 8'	2,150 lbs	330 lbs
Corner	460 lbs	70 lbs

# FLOATING POLYDOCK

## DOCK ACCESSORIES

### MODELS AND SPECIFICATIONS

#### FLOATING POLYDOCK ACCESSORIES

#### NET PRICE

QCFLAG	QuickConnect™ Flagpole Holder (REQUIRES ACCESSORY CONNECTOR #PDACCCN)	\$97.00
FLAGPOLE	20' Anodized Aluminum Flagpole (INCLUDES 3'X5' AMERICAN FLAG)	\$459.00
CHAINANCHOR	Chain Anchor Plate (REQUIRES ACCESSORY CONNECTOR #PDACCCN)	\$89.00
POLYWHEELCADDY	PolyDock Wheel Caddy (PAIR, TIRES SOLD SEPARATELY)	\$229.00
VDBPOLY	PolyDock QuickConnect™ Vertical Dock Bumper	\$207.00
8ARCPOLY	8" Poly Rope Cleat	\$34.00

#### DOCK LADDERS

3LADQC	3 Step QuickConnect™ Ladder* (34" FROM TOP OF DOCK TO BOTTOM OF LADDER)	\$289.00
4LADQC	4 Step QuickConnect™ Ladder* (46" FROM TOP OF DOCK TO BOTTOM OF LADDER)	\$329.00
5LADQC	5 Step QuickConnect™ Ladder* (58" FROM TOP OF DOCK TO BOTTOM OF LADDER)	\$399.00

\*REQUIRES LADDER CONNECTOR #POLYLADCONN.

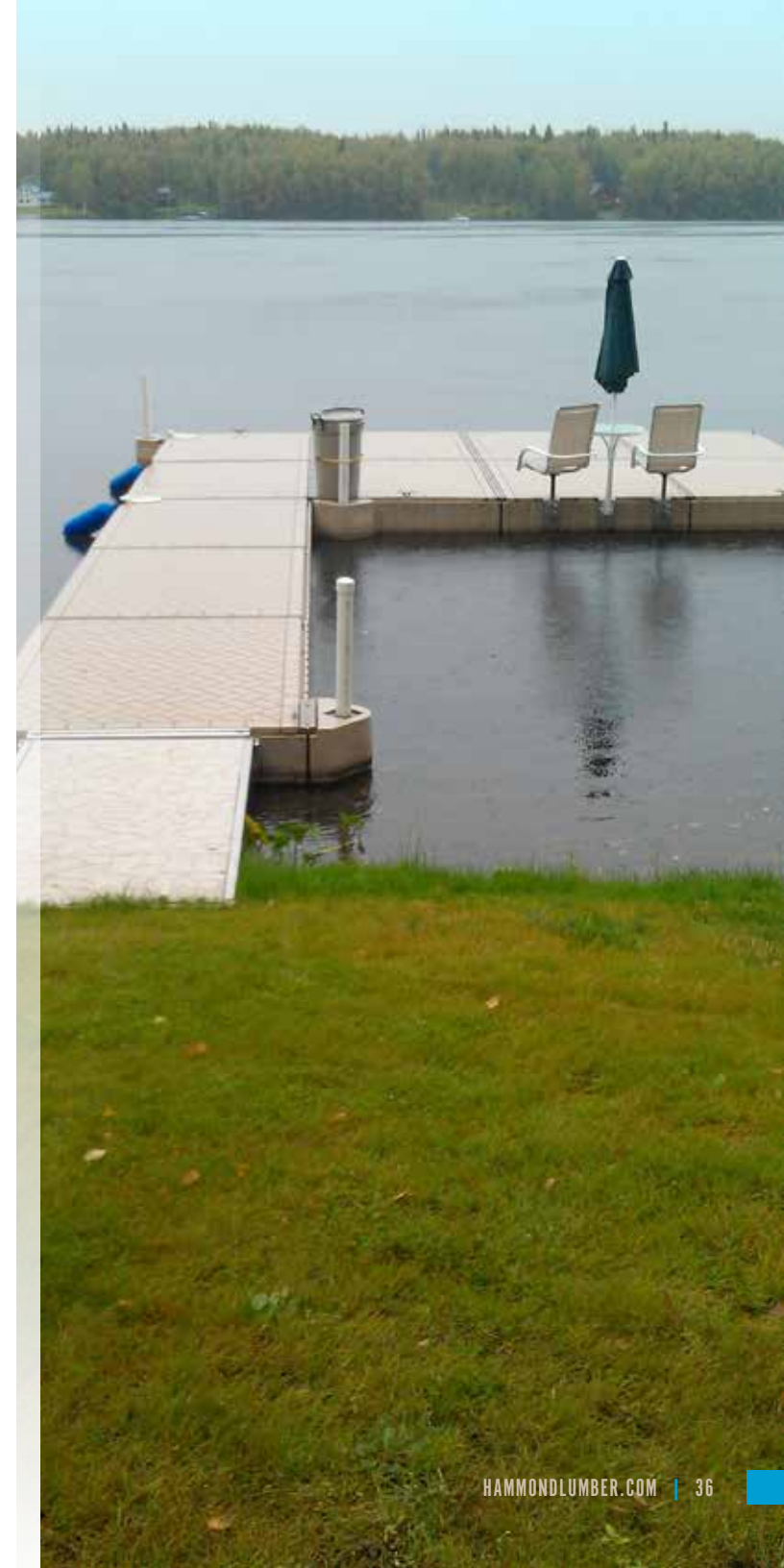



# FLOATING FTS9 DOCK

PREMIUM FLotation. SUPERIOR STABILITY.

Little Ossipee Lake, Waterboro, Maine

## benefits

### FLUCTUATING AND DEEP WATER SOLUTION

ShoreMaster's FTS9 is the premium choice to address your fluctuating and deep water challenges.

### SUPERIOR STRENGTH

9" classic truss sides and welded aluminum frame provide superior strength and timeless durability.

### REMARKABLE STABILITY

Premium dock flotation adds remarkable stability to the solid truss frame.

### EASY CUSTOMIZATION

The QuickConnect™ accessory system makes it easy to install and remove accessories without tools.

### THE MOST DECKING OPTIONS

Achieve your desired look by choosing from ShoreMaster's 8 premium decking options including Cedar, Vertex™, Painted Aluminum and more.



**ENDLESS CONFIGURATIONS**  
for virtually unlimited layouts or designs.

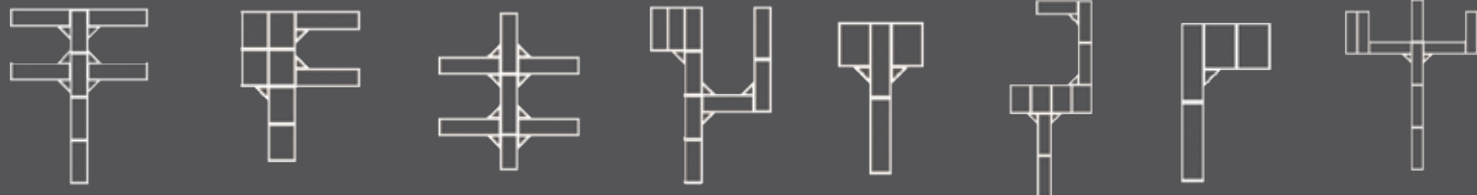

# FLOATING FTS9 DOCK

PREMIUM FLOTATION. SUPERIOR STABILITY.

## MODELS AND SPECIFICATIONS

### 4' X 8' FTS9 FLOATING DOCK

		NET PRICE
FTS948RCD	4' x 8' Floating Dock - Premium Cedar Deck	\$1,229.00
FTS948IPE	4' x 8' Floating Dock - Hardwood IPE Deck	\$1,799.00
FTS948AD	4' x 8' Floating Dock - Plain Aluminum Deck	\$1,349.00
FTS948PED	4' x 8' Floating Dock - White Aluminum Deck	\$1,499.00
FTS948TPD	4' x 8' Floating Dock - Tan Aluminum Deck	\$1,499.00
FTS948WGD	4' x 8' Floating Dock - Traditional Woodgrain Aluminum Deck	\$1,539.00
FTS948GOWGD	4' x 8' Floating Dock - Gray Oak Woodgrain Aluminum Deck	\$1,539.00
FTS948VD	4' x 8' Floating Dock - Vertex™ Deck	\$1,429.00
FTS948TGD	4' x 8' Floating Dock - Tan Deck	\$1,449.00
FTS948GGD	4' x 8' Floating Dock - Gray Deck	\$1,449.00

(ONE TS9 4' X 8' DOCK SECTION TAKES 2 EACH 2' X 4'-12" FLOATS; INCLUDED IN PRICE)

### 4' X 16' FTS9 FLOATING DOCK

FTS9416RCD	4' x 16' Floating Dock - Premium Cedar Deck	\$2,369.00
FTS9416IPE	4' x 16' Floating Dock - Hardwood IPE Deck	\$3,399.00
FTS9416AD	4' x 16' Floating Dock - Plain Aluminum Deck	\$2,659.00
FTS9416PED	4' x 16' Floating Dock - White Aluminum Deck	\$2,869.00
FTS9416TPD	4' x 16' Floating Dock - Tan Aluminum Deck	\$2,869.00
FTS9416WGD	4' x 16' Floating Dock - Traditional Woodgrain Aluminum Deck	\$2,939.00
FTS9416GOWGD	4' x 16' Floating Dock - Gray Oak Woodgrain Aluminum Deck	\$2,939.00
FTS9416VD	4' x 16' Floating Dock - Vertex™ Deck	\$2,729.00
FTS9416TGD	4' x 16' Floating Dock - Tan Glacier Deck	\$2,789.00
FTS9416GGD	4' x 16' Floating Dock - Gray Glacier Deck	\$2,789.00

(ONE TS9 4' X 16' DOCK SECTION TAKES 4 EACH 2' X 4'-12" FLOATS; INCLUDED IN PRICE)

### FTS9 FLOATING DOCK CORNERS

FTS9CDSRC	Corner Section for Floating Dock - Premium Cedar Deck	\$329.00
FTS9CDSIPE	Corner Section for Floating Dock - Hardwood IPE Deck	\$529.00
FTS9CDSAL	Corner Section for Floating Dock - Plain Aluminum Deck	\$399.00
FTS9CDSPA	Corner Section for Floating Dock - White Aluminum Deck	\$429.00
FTS9CDSTP	Corner Section for Floating Dock - Tan Aluminum Deck	\$429.00
FTS9CDSWG	Corner Section for Floating Dock - Traditional Woodgrain Aluminum Deck	\$469.00
FTS9CDGOWGD	Corner Section for Floating Dock - Gray Oak Woodgrain Aluminum Deck	\$469.00
FTS9CDSV	Corner Section for Floating Dock - Vertex™ Deck	\$439.00
FTS9CDSTGD	Corner Section for Floating Dock - Tan Glacier Deck	\$449.00
FTS9CDSGGD	Corner Section for Floating Dock - Gray Glacier Deck	\$449.00



## options

### QUICKCONNECT™ DOCK FURNITURE

Relax on your dock in style. The QuickConnect™ Dock Furniture comes with 2 chairs, a table, and an umbrella.

### FTS9 CORNER DOCK SECTIONS

Added safety for kids and adults, while adding stability to your dock system.

### QUICKCONNECT™ ROPE CLEAT

Temporarily moor your boat by installing a Cleat anywhere along your dock without additional drilling.

### QUICKCONNECT™ LAKEVIEW BENCH

With the QuickConnect™ system, you can mount this bench anywhere on the dock. Add the optional armrest with beverage holder for extra comfort.





# FLOATING FTS9 DOCK

PREMIUM FLOTATION. SUPERIOR STABILITY.

## MODELS AND SPECIFICATIONS

### FTS9 DOCK ACCESSORIES

		NET PRICE
QCRC	QuickConnect™ Rope Cleat	\$33.00
TS9RC	Ramp Connector for FTS9	\$189.00
FTS9CONN	Frame Connector for FTS9	\$36.00
QCPIPE	QuickConnect™ Pipe Bracket*	\$174.00
FTS9CHAIN	Chain Anchor Kit for FTS9*	\$91.00
FTS9CHAINANGLE	Chain Anchor Angle Kit for FTS9	\$123.00
221GP	2" x 21" Galvanized Pipe (NO CUTTING)	\$199.00
24CBA	24" Cement Boat Anchor 225 lbs.	\$36.00
TLBQC	QuickConnect™ Lakeview Bench**	\$349.00
LVARM	Arm Rest for Lakeview Bench	\$149.00
CANOERACK	QuickConnect™ Canoe, Kayak, and Paddle Board Rack**	\$249.00
FURNITURE	QuickConnect™ Dock Furniture (2 CHAIRS, TABLE AND UMBRELLA)***	\$925.00

### DOCK LADDERS

3LADQC	3 Step QuickConnect™ Ladder** (34" FROM TOP OF DOCK TO BOTTOM OF LADDER)	\$289.00
4LADQC	4 Step QuickConnect™ Ladder** (46" FROM TOP OF DOCK TO BOTTOM OF LADDER)	\$339.00
5LADQC	5 Step QuickConnect™ Ladder** (58" FROM TOP OF DOCK TO BOTTOM OF LADDER)	\$399.00

### QUICKCONNECT™ ACCESSORY BRACKET

TS9QCBR	FTS9 QuickConnect™ Accessory Bracket	\$39.00
---------	--------------------------------------	---------



\*REQUIRES 1 EACH QUICKCONNECT™ ACCESSORY BRACKETS.

\*\*REQUIRES 2 EACH QUICKCONNECT™ ACCESSORY BRACKETS. \*\*\*REQUIRES 3 EACH QUICKCONNECT™ ACCESSORY BRACKETS.



# SHOREPORT™

EASY ON. EASY OFF. ALWAYS READY.

## MODELS AND SPECIFICATIONS

### SHOREPORT™ AND ACCESSORIES

### NET PRICE

SHOREPORT	Shoreport™ (1,150 LB. CAPACITY, ADD ADDITIONAL FLOTATION 50LBS AT A TIME UP TO 1,450LBS)	\$1,539.00
LASPRNTC	Front Shoreport™ Connector (SHOREPORT™ TO FRONT POLYDOCK)	\$267.00
SFRNTC	Side Front Connector (SHOREPORT™ TO SHOREPORT ONLY)	\$128.00
SRRC	Side Rear Connector 12"	\$94.00
DASPSTOFF	Stand Off Plate (PAIR, SHOREPORT™ TO STANDING DOCK)	\$316.00
POLYPIPEBRA	Poly Pipe Bracket Complete	\$231.00
SMALLPIPE	Light Duty Poly Pipe (TWO HALVES & BOLTS)	\$145.00
REARPIPE	Shoreport™ Rear Pipe Bracket Complete	\$125.00
FLEXIHINGE	Shoreport™ Flexi-Hinge (PAIR)	\$379.00
SPFHTOSPF9	Shoreport™ Hinge to FTS9 Bracket Kit Complete (PAIR) (MUST ADD TO FLEXI-HINGE)	\$155.00
RPSUPFL	Shoreport™ Supplemental Float (EACH) (ADDS 50LBS. CAPACITY PER FLOAT, SHOULD BE USED IN PAIRS)	\$112.00
KAYAKLAUNCH	Kayak Launch (REQUIRES PURCHASE OF SHOREPORT, SIDE FRONT CONNECTOR, AND AT LEAST ONE SECTION OF POLYDOCK)	\$1,169.00
SAKAYAKLAUNCH	Stand Alone Kayak Launch (REQUIRES PURCHASE OF SHOREPORT, SIDE FRONT CONNECTOR, AND AT LEAST ONE SECTION OF POLYDOCK)	\$1,269.00

NEW!

### KAYAK LAUNCH

Safely and easily dry launch your kayak or canoe. Guard rails make it easy to enter and exit the launch, and the kayak launch's three rollers make the transition between the water and the kayak launch super smooth.

DESIGNED FOR  
EASE-OF-USE AND  
CONNECTIVITY

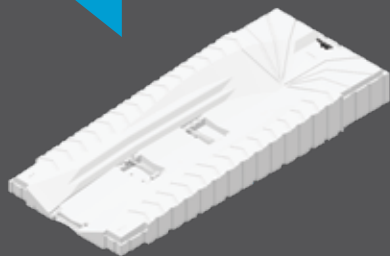

## features

### FLEXI-HINGE

Designed to allow Shoreport™ to attach to most floating dock systems.

### STAND-OFF / PIPE BRACKET

Designed to attach Shoreport™ to fixed and standing dock systems.

### FRONT END CONNECTION

Easy clamp design allows for sturdy alternative attachment to ShoreMaster Shoreport™.

### KEEL ROLLER

Our standard three roller system provides easy drive on and roll off launching. The clear non-marring poly rollers are adjustable to conform to any hull design.

### EXTENDED STORAGE

8" cleat quickly and easily ties down your personal watercraft for safe and secure extended storage.

## capacity

SIZE	CAPACITY	WEIGHT
56"x138"	1,150 lbs*	260 lbs

\*Add additional flotation 50 lbs at a time, up to 1,450 lbs

# SHOREMASTER FLOTATION

## EXCEPTIONAL FLOTATION IN A SINGLE MOLD.

### MODELS AND SPECIFICATIONS

#### SHOREMASTER FLOTATION FLAT TOP

ITEM NUMBER	FLOAT SIZE	APPROX. CAPACITY	CUBIC FT. PER FLOAT	FLOAT WEIGHT	NET PRICE
FLOAT2312	2' x 3' x 12"	315 lbs.	22	18 lbs.	\$119.00
FLOAT0425 (STOCK)	2' x 4' x 12"	425 lbs.	8	30 lbs.	\$137.00
FLOAT0665 (STOCK)	3' x 4' x 12"	650 lbs.	12	47 lbs.	\$185.00
FLOAT4412	4' x 4' x 12"	875 lbs.	16	60 lbs.	\$229.00
FLOAT1300	4' x 6' x 12"	1350 lbs.	24	80 lbs.	\$313.00
FLOAT4812	4' x 8' x 12"	1850 lbs.	32	105 lbs.	\$394.00
FLOAT0565	2' x 4' x 16"	550 lbs.	10.7	40 lbs.	\$170.00
FLOAT0725	2' x 5' x 16"	700 lbs.	13.3	50 lbs.	\$196.00
FLOAT0900	3' x 4' x 16"	875 lbs.	16	55 lbs.	\$203.00
FLOAT1350	3' x 6' x 16"	1350 lbs.	24	75 lbs.	\$280.00
FLOAT1250	4' x 4' x 16"	1225 lbs.	21.3	65 lbs.	\$251.00
FLOAT1800	4' x 6' x 16"	1850 lbs.	32	105 lbs.	\$339.00
FLOAT2500	4' x 8' x 16"	2500 lbs.	42.7	135 lbs.	\$456.00
FLOAT1420	1' x 4' x 20"	340 lbs.	6.7	24 lbs.	\$139.00
FLOAT2420	2' x 4' x 20"	725 lbs.	13.33	50 lbs.	\$196.00
FLOAT1100	3' x 4' x 20"	1100 lbs.	20	60 lbs.	\$236.00
FLOAT1500	4' x 4' x 20"	1500 lbs.	26.7	85 lbs.	\$280.00
FLOAT3620	3' x 6' x 20"	1680 lbs.	30	90 lbs.	\$317.00
FLOAT2300	4' x 6' x 20"	2300 lbs.	40	120 lbs.	\$405.00
FLOAT3000	4' x 8' x 20"	3050 lbs.	53.3	155 lbs.	\$526.00
FLOAT2424	2' x 4' x 24"	865 lbs.	16	58 lbs.	\$218.00
FLOAT3424	3' x 4' x 24"	1300 lbs.	24	63 lbs.	\$262.00
FLOAT2000	3' x 6' x 24"	2000 lbs.	36	112 lbs.	\$390.00
FLOAT1750	4' x 4' x 24"	1750 lbs.	32	100 lbs.	\$306.00
FLOAT2700	4' x 6' x 24"	2700 lbs.	48	140 lbs.	\$471.00
FLOAT3650	4' x 8' x 24"	3650 lbs.	64	175 lbs.	\$610.00
FLOAT3432	3' x 4' x 32"	1730 lbs.	32	86 lbs.	\$372.00
FLOAT4632	4' x 6' x 32"	3600 lbs.	64	165 lbs.	\$610.00

#### SHOREMASTER FLOTATION RAISED CORNERS

FLOAT0250 (STOCK)	21" x 35" x 12"	250 lbs.	5.1	21 lbs.	\$119.00
FLOAT0850	35" x 45" x 21"	825 lbs.	19.1	52 lbs.	\$218.00

#### SHOREMASTER FLOTATION RACEWAY TOP

FLOAT0950	35" x 44" x 16"	900 lbs.	14.3	51 lbs.	\$225.00
-----------	-----------------	----------	------	---------	----------



### EXCEPTIONAL FLOTATION IN A SINGLE MOLD.

Whether you're replacing floats on your old floating dock or building a new floating dock system, you can't beat the exceptional value and quality of ShoreMaster Flotation. Our floats are rotationally molded for a seamless one piece construction that will remain watertight for years to come. The durable polyethylene shell contains UV inhibitors and carbon black pigment to protect against UV degradation.



#### POLYSTYRENE FOAM FILLED

Foam filled with expanded polystyrene beads to prevent loss of buoyancy due to puncture or damage to the outer shell. This meets the Hunt Absorption Test.



#### EXCEPTIONAL STRENGTH

Ribbed sidewalls provide greater strength and more uniform walls.



#### PREMIUM SUPPORT

Deeper mounting flange offers greater support in mounting areas.

# RHINOFLOAT

PREMIUM DOCK FLOTATION. TRUSTED EVERYWHERE.

## MODELS AND SPECIFICATIONS

### 12" RHINOFLOAT FLAT TOP

ITEM NUMBER	FLOAT SIZE	APPROX. CAPACITY	CUBIC FT. PER FLOAT	FLOAT WEIGHT	NET PRICE
RF3212	2' x 3' x 12"	315 lbs.	6	18 lbs.	\$116.00
RF2412 (STOCK)	2' x 4' x 12"	425 lbs.	8	30 lbs.	\$129.00
RF3412 (STOCK)	3' x 4' x 12"	650 lbs.	12	47 lbs.	\$173.00
RF4412 (STOCK)	4' x 4' x 12"	875 lbs.	16	60 lbs.	\$215.00
RF4612 (STOCK)	4' x 6' x 12"	1350 lbs.	24	80 lbs.	\$296.00
RF4812	4' x 8' x 12"	1850 lbs.	32	105 lbs.	\$366.00

### 16" RHINOFLOAT FLAT TOP

RF2416	2' x 4' x 16"	550 lbs.	10.7	40 lbs.	\$153.00
RF3416	3' x 4' x 16"	875 lbs.	16	55 lbs.	\$190.00
RF3616	3' x 6' x 16"	1350 lbs.	24	75 lbs.	\$260.00
RF4416	4' x 4' x 16"	1225 lbs.	21.3	65 lbs.	\$231.00
RF4616	4' x 6' x 16"	1850 lbs.	32	105 lbs.	\$318.00
RF4816	4' x 8' x 16"	2500 lbs.	42.7	135 lbs.	\$421.00

### 20" RHINOFLOAT FLAT TOP

RF2420	2' x 4' x 20"	725 lbs.	13.33	50 lbs.	\$180.00
RF3420	3' x 4' x 20"	1100 lbs.	20	60 lbs.	\$219.00
RF3620	3' x 6' x 20"	1680 lbs.	30	90 lbs.	\$305.00
RF4420	4' x 4' x 20"	1500 lbs.	26.7	85 lbs.	\$260.00
RF4620	4' x 6' x 20"	2300 lbs.	40	120 lbs.	\$372.00
RF4820	4' x 8' x 20"	3050 lbs.	53.3	155 lbs.	\$486.00

### 24" RHINOFLOAT FLAT TOP

RF2424	2' x 4' x 24"	865 lbs.	16	58 lbs.	\$219.00
RF3424	3' x 4' x 24"	1300 lbs.	24	63 lbs.	\$241.00
RF3624	3' x 6' x 24"	2000 lbs.	36	112 lbs.	\$365.00
RF4424	4' x 4' x 24"	1750 lbs.	32	100 lbs.	\$292.00
RF4624	4' x 6' x 24"	2700 lbs.	48	140 lbs.	\$434.00
RF4824	4' x 8' x 24"	3650 lbs.	64	165 lbs.	\$566.00

### 32" RHINOFLOAT FLAT TOP

RF3432	3' x 4' x 32"	1730 lbs.	32	86 lbs.	\$345.00
RF4632	4' x 6' x 32"	3600 lbs.	64	165 lbs.	\$632.00



## PREMIUM DOCK FLOTATION. TRUSTED BY DOCK BUILDERS EVERYWHERE.

Dock builders and dock installers everywhere rely on RhinoFloat premium dock flotation to float their customers' floating dock systems because of their durability, impact resistance, and premium construction. With completely encapsulated expanded polystyrene foam interior, RhinoFloat can withstand even the harshest marine environment.



### POLYSTYRENE FOAM FILLED

Foam filled with expanded polystyrene beads to prevent loss of buoyancy due to puncture or damage to the outer shell. This meets the Hunt Absorption Test.



### "J" BOLT COMPATIBLE SLOTS

Quick and easy installation is provided by RhinoFloats "J" bolt compatible attachment slots. Slotted attachment locations allow the dock builder or installer to position the RhinoFloat nearly anywhere along the dock frame.



# QUICKCONNECT™

THE EASIEST WAY TO CUSTOMIZE YOUR DOCK



## A DOCK SYSTEM THAT EVOLVES WITH YOU. COMPLETE CUSTOMIZATION

Imagine adding, removing, or reconfiguring your dock accessories at a moment's notice, and without the need for tools. When you choose a ShoreMaster dock system, you'll enjoy the convenience of QuickConnect accessories.



### QUICKCONNECT BRACKET

After the initial setup, you will never need tools to adjust or reconfigure your dock accessories. You won't find an easier system anywhere else.

### SHOREMASTER EXCLUSIVE

T-handle installation. No drilling. No holes. Change your mind at a moment's notice. Tool free reconfiguration and easy installation.



# QUICKCONNECT™ ACCESSORIES

THE EASIEST WAY TO CUSTOMIZE YOUR DOCK.



## DOCK FURNITURE

CHAIRS, TABLE AND UMBRELLA | QUICKCONNECT

Enjoy your waterfront more from the comfort of your dock system. Furniture and benches are easy to add, remove and adjust for a beautiful look and relaxing atmosphere.

Furniture set comes with 2 chairs, table and umbrella (two sets shown at left). On- and Off-Dock benches available with and without armrests.



## **NEW!** HOMECREST DOCK FURNITURE (SPECIAL-ORDER)

CHAIRS, TABLE AND UMBRELLA | QUICKCONNECT

Our NEW premium dock furniture, from Homecrest Outdoor Living, utilizes a model design and versatile Hickory finish. The chairs feature a swivel rock functionality for your comfort.

Two styles of furniture available; see dealer for details. Available in 5 chair fabric options:



## QUICK STEPS

4- AND 6-STEP OPTIONS | PIVOTING ANGLE | TWO STYLES AVAILABLE | QUICKCONNECT

ShoreMaster's NEW Quick Steps feature a wider step, deep tread and can be used as dock steps or landscaping steps for the ultimate waterfront experience. Also available are our standard dock steps.

4- and 6-step options available in both styles.

QuickSteps feature 33.75" stair opening, 41" overall width, and 7.125" stair tread.



## PIVOT LADDER

3-, 4-, AND 5-STEP OPTIONS | QUICKCONNECT

Get in and out of the water easily with ShoreMaster's QC Pivot Ladders. A vertical pivoting action and locking pin allows you to flip the ladder up when you're not using it, making it ideal for swimmers.

3-, 4-, and 5-step options available.



# QUICKCONNECT™ ACCESSORIES

THE EASIEST WAY TO CUSTOMIZE YOUR DOCK.

## PADDLEBOARD/KAYAK RACK

SINGLE AND DOUBLE RACK OPTIONS | QUICKCONNECT

Store your paddleboard, kayak or canoe off of your dock with an accessory bracket that attaches to the outside perimeter of your dock at any location.

Single and double rack options available. Versatile design can accommodate nearly any watersport equipment including paddleboards, kayaks, and canoes.



## NEW! STAND-UP PADDLEBOARD RACK

EASY, SECURE BOARD & PADDLE STORAGE | QUICKCONNECT

Our SUP storage rack is the best way to store your Stand Up Paddleboards dockside so they are ready to ride whenever you are. The SUP Storage Rack is designed to fit any style of stand up paddle board, and the storage rack arms are vertically adjustable so you can store your SUP at the perfect height for you. With easy installation and seamless protection for our paddle boards we make it even more convenient for you to get out on your next paddling adventure.



## DOCK BENCH

AVAILABLE WITH OR WITHOUT ARMRESTS | QUICKCONNECT

Add comfort and style to your dock system with a dock bench. Available with and without armrests, the Lakeview dock bench offers the perfect spot to enjoy a morning cup of coffee or an evening of relaxation on the water. Plus, with QuickConnect, your bench can attach anywhere on the dock system and move at a moment's notice - so you'll never miss a sunrise or sunset.



## NEW! SOLAR DOCK LIGHTS

NO CORD OR WIRING | SOLAR POWERED | EASY INSTALL | 5 COLORS AVAILABLE

Set your Infinity Dock System aglow in the evening with solar paneled dock lights from ShoreMaster.

Mounted directly into the dock leg caps our dock lights are easy to install and offer an attractive and unobtrusive low profile – no tripping, no wasted dock space. A bright solar powered LED light provides an evening illumination without the hassle of cords or wires. Available in white, blue, amber, red or green.





175

# ALUMINUM LIFTS

You can rely on an aluminum boat lift from ShoreMaster to improve your boating experience by providing you with an easy and dependable way to access and store your boat. When you choose the safety, dependability, and simplicity of a ShoreMaster boat lift, you'll spend more time boating with your friends and family, and less time performing maintenance and making adjustments to your lift. ShoreMaster lifts can be configured to fit any style of boat. No matter how you boat, you'll enjoy it more with a ShoreMaster boat lift.

## PREMIUM LIFT OPTIONS:

- Vertical Lifts
- Pontoon Lifts
- Cantilever Lifts
- Hydraulic Lifts



# VERTICAL LIFT

DURABLE. SIMPLE. VERSATILE BOAT STORAGE.



WIDE ARRAY  
OF AVAILABLE  
ACCESSORIES

## *benefits*

### PREMIUM PERFORMANCE

Welded construction provides superior durability over bolt together lifts, with easier assembly and installation.

### EASY ACCESS

Our double V-side design provides safe and convenient access from either side of the lift.

### INCREDIBLE RELIABILITY

The Whisper Winch™ offers quiet operation with incredible reliability.

### CONVENIENT OPERATION

Up to 66" lift rack travel offers easy, convenient lift operation in fluctuating water conditions.

### EASY ADJUSTMENTS

Lift screw legs attach to the lift uprights to accommodate height adjustments due to fluctuating water levels.

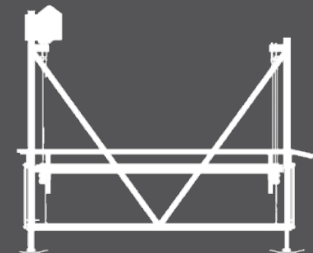
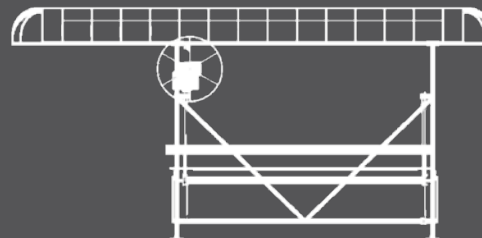
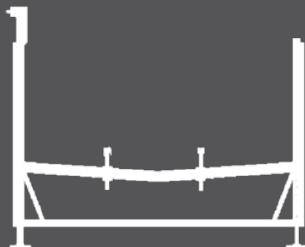

# VERTICAL LIFT

## LIFT AND ACCESSORIES

### MODELS AND SPECIFICATIONS

#### VERTICAL LIFT

MODEL	WEIGHT CAPACITY	INSIDE WIDTH	LIFT HEIGHT	LIFT WEIGHT	STANDARD LEG LENGTH	OVERALL WIDTH	WINCH MODEL	CANOPY LENGTH	NET PACKAGE PRICE*
SM30966	3,000 lbs.	108"	66"	360 lbs.	36"	120"	Whisper Winch	21' - 27'	\$5,295.00
SM40966	4,000 lbs.	108"	66"	405 lbs.	36"	120"	SM 4000 HD	21' - 27'	\$5,895.00
SM401066V	4,000 lbs.	120"	66"	425 lbs.	36"	132"	SM 4000 HD	23' - 33'	\$5,995.00
SM2208	2,200 lbs.	96"	66"	283 lbs.	36"	120"	Whisper Winch	21'	\$4,395.00

#### VERTICAL LIFT ACCESSORIES

		NET PRICE
C5LEG	5' Boat Lift Leg	\$160.00
C7LEG	7' Boat Lift Leg	\$190.00
430015765	Easy Adjust Legs (PAIR)	\$487.00
WC	Wheel Caddy (PAIR)	\$789.00
BOWSTOP	Bow Guide	\$719.00
LADEPBRAC	Boat Lift Deep Water Brace (PAIR, SUPPORTS TWO LEGS)	\$240.00

(NEEDED IF 5' OR MORE OF THE LIFT LEGS ARE EXTENDED OUT OF THE LIFT SIDES)



Find our Canopy Covers on page 64

\*PACKAGE INCLUDES ASSEMBLY, FULL LENGTH BUNKS, FULL LENGTH GUIDES, AND MOTOR STOP.

**WARNING:** DRY BOAT WEIGHTS ARE OFTEN UNDERSTATED BY THE MANUFACTURER. ALSO THEY DO NOT INCLUDE GAS, GEAR, ETC. WEIGH YOUR BOAT FULLY LOADED TO GET ACCURATE WEIGHT. WARRANTY IS VOID IF THE LIFT CAPACITY IS EXCEEDED.



### DURABLE. SIMPLE. VERSATILE BOAT STORAGE.

ShoreMaster's vertical lift is designed to work in shallow, deep, or fluctuating water conditions. ShoreMaster's all-aluminum welded construction provides a lightweight, maintenance free lift for greater strength and durability.

The double V-Side design allows for easy access to both sides of your boat. These lifts provide safe, secure mooring with virtually maintenance free operation.



#### WHEEL CADDY

Attached to each lift side and designed to assist in lift installation and removal, the Wheel Caddy can remain on the lift year round.

Simply disconnect two chains and tighten the set screw to use the lift.

# PONTOON LIFT

STABILITY. DESIGNED FOR TODAY'S PONTOONS.



## *benefits*

### **SUPERIOR STABILITY**

Our frames provide better stability for today's pontoons.

### **PREMIUM PERFORMANCE**

Welded construction provides superior durability over bolt-together lifts, with easier assembly and installation.

### **EASY ACCESS**

Double V-side design provides safe and convenient access from either side of the lift.

### **PREMIUM PROTECTION**

Pontoon Guide Rails offer non-marring protection and even weight distribution.

### **EASY OPERATION**

Optional Lift Boss™ boat lift power unit increases your ease of operation.



**WIDE ARRAY  
OF AVAILABLE  
ACCESSORIES**

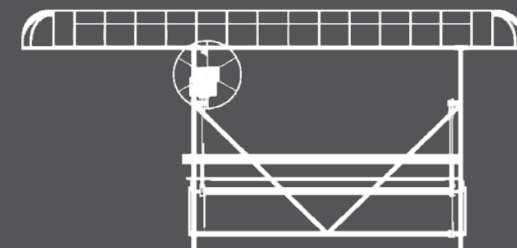
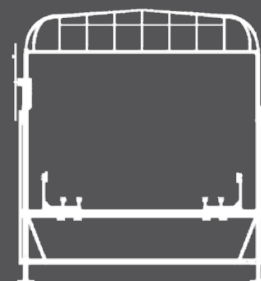
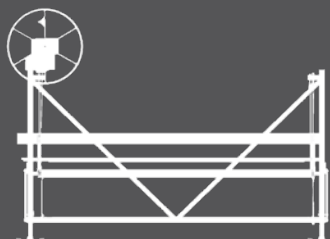

# PONTOON LIFT

## LIFT AND ACCESSORIES

### MODELS AND SPECIFICATIONS

VERTICAL LIFTS		NET PACKAGE PRICE
SM401066PRV	SM4010 DVS w/ Pontoon Racks and Pontoon Motor Stop	\$5,395.00
SM401066PRK	SM4010 DVS w/ Pontoon Rail Kit and Pontoon Motor Stop	\$5,295.00
SM5510PTNDVS	SM5510 DVS Pontoon Lift w/ Pontoon Guides, Cradles, & Blue Wheel	\$9,549.00
SM701168PTN	SM7011 Tri-toon Pontoon Lift w/ Tri-toon Center Cradle & Motor Stop <small>THIS IS AN OVERSIZED LOAD, MAY REQUIRE ADDITIONAL TIME AND HELP</small>	\$14,595.00

VERTICAL LIFT ACCESSORIES		NET PRICE
C5LEG	5' Boat Lift Leg	\$160.00
C7LEG	7' Boat Lift Leg	\$190.00
11CBB	11' Carpeted 2x6 Bunk Boards for Tri-Toon Cradle or V-Rack Pontoon Guide Brackets	\$279.00
WC	Wheel Caddy (PAIR)	\$789.00
TTCC7PTNL	Tri-Toon Center Cradle for 7000# Pontoon Lift	\$1,259.00
TTCC55PTNL	Tri-Toon Center Cradle w/ Vinyl Bunks for 5510# Pontoon Lift	\$719.00
FLG	11' Full Length Guide Aluminum/Carpeted Bunk	\$595.00

PONTOON RACKS		NET PRICE
PRC	Cantilever Pontoon Racks (SET OF 4) <small>(FOR 30108-40108 CANTILEVER &amp; 3K &amp; 4K STRAIGHT RACK VERTICAL)</small>	\$596.00
PRV	V-Rack Pontoon Racks (SET OF 4) <small>(FOR 30966, 40966, 401066 V-RACK VERTICAL LIFTS)</small>	\$632.00
PRV	V-Rack Pontoon Racks (SET OF 4)	\$632.00
VRACKPGBR	V-Rack Ponton Guide Bracket & Hardware Only (SET OF 4)	\$229.00

PONTOON RAIL KIT BRACKETS		
LAPRLBRST	Pontoon Rail Kit Brackets Straight Rack (SET OF 4) <small>(FOR 1600-5000 CANTILEVER &amp; 3K &amp; 4K STRAIGHT RACK VERTICAL)</small>	\$510.00
LAPRBRVST	Pontoon Rail Kit Brackets Vertical Rack (SET OF 4) <small>(FOR 30966, 40966, 401066 V-RACK VERTICAL LIFTS)</small>	\$521.00

PONTOON MOTOR STOPS		
LASRPMTRS	Pontoon Adjustable Motor Stop (STRAIGHT RACK)	\$225.00
LAVRPMTRS	Pontoon Adjustable Motor Stop (V-RACK)	\$282.00

BOAT LIFT HANDRAIL		
BLHANDRAIL	Boatlift Handrail**	\$199.00

QUICKCONNECT™ ACCESSORY BRACKET		
RS4QCBR	RS4 QuickConnect™ Accessory Bracket	\$34.00
RS7QCBR	RS7 QuickConnect™ Accessory Bracket	\$37.00
TS9QCBR	FTS9 QuickConnect™ Accessory Bracket	\$39.00

\*\*REQUIRES 2 EACH QUICKCONNECT™ ACCESSORY BRACKETS.

**WARNING:** DRY BOAT WEIGHTS ARE OFTEN UNDERSTATED BY THE MANUFACTURER. ALSO THEY DO NOT INCLUDE GAS, GEAR, ETC. WEIGH YOUR BOAT FULLY LOADED TO GET ACCURATE WEIGHT. WARRANTY IS VOID IF THE LIFT CAPACITY IS EXCEEDED.

## options

### STABILITY. DESIGNED FOR TODAY'S PONTOONS.

ShoreMaster's Pontoon Lift has been designed to perfectly fit today's larger, more powerful, and more refined pontoon boats. With new pontoon specific accessories, you can be sure that your new pontoon will be protected by a ShoreMaster pontoon lift.



### BOAT LIFT HANDRAIL

With the ShoreMaster lift handrail, it's easier to climb in and out of your lift system.



### PONTOON RAIL KIT

Acts as both a lifting device as well as a centering guide.



### PONTOON RACKS

All Pontoon Racks are aluminum construction and come as a set of four. They are designed to provide a surface for your pontoons to rest on and are adjustable horizontally on the lift rack.



### PONTOON MOTOR STOP

Assists in centering your pontoon fore and aft.

# PONTOON LIFTS

## DESIGNED SPECIFICALLY FOR A PONTOON.

### MODELS AND SPECIFICATIONS

#### PONTOON LIFT

MODEL	WEIGHT CAPACITY	INSIDE WIDTH	LIFT HEIGHT	STANDARD LEG	OVERALL WIDTH	OVERALL LENGTH	WINCH MODEL	CANOPY LENGTH	LIFT WEIGHT
4010PTN	4,000 lbs.	120"	66"	36"	132"	162"	241 Whisper	23'-33'	836 lbs.
5500PTN	5,500 lbs.	120"	66"	36"	132"	162"	241 Whisper	23'-33'	933 lbs.
701168PTN	7,000 lbs.	132"	68"	36"	144"	216"	SM7000	27'-35'	1,315 lbs.



Additional Center Toon is Available.



### CLASSIC DESIGN. BUILT TO LAST. EASY TO OWN.

Our engineers took special consideration when designing the ShoreMaster pontoon lift to ensure stability and durability for your larger watercrafts.

An all-aluminum welded frame along with stainless cables and brass sheaves provides a stable base that you can be confident will always protect your pontoon. Our full-length pontoon racks are adjustable to fit your specific boat and help to evenly distribute the weight of the boat across the lift. Available in two weight capacities - 4,000 lbs and 7,000 lbs - our pontoon lifts take the work out of raising and lowering your boat with our time-tested winches.

### NEW FEATURES

Designed specifically for a pontoon, this lift includes a longer and wider frame for greater stability. The full length bunks and guides provide more support while the double V-Sides allow easy access!





# TRI-TOON LIFTS

PREMIUM SUPPORT DESIGNED FOR TODAY'S TRI-TOON.

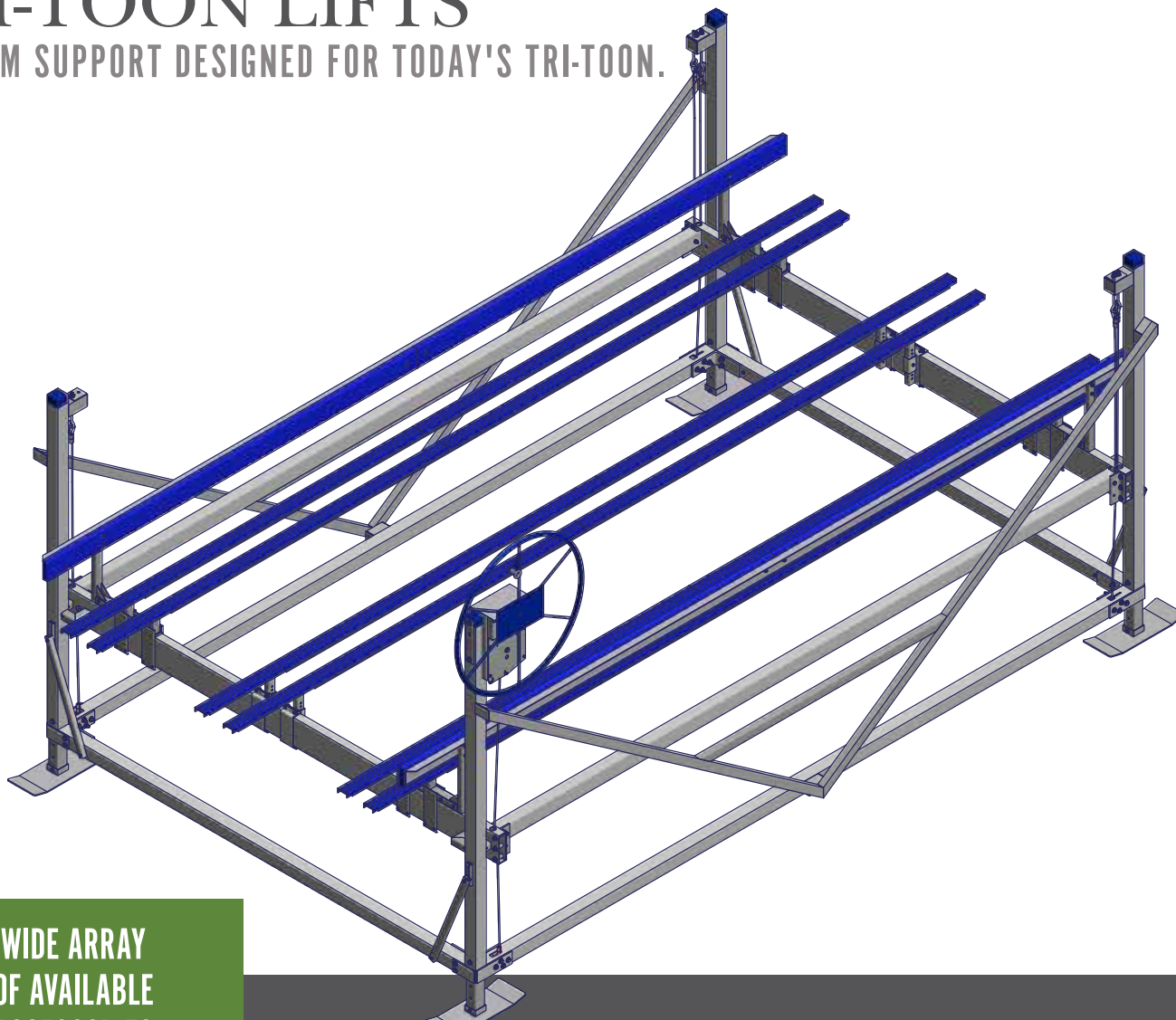

WIDE ARRAY  
OF AVAILABLE  
ACCESSORIES

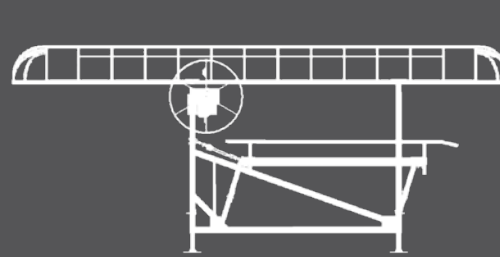
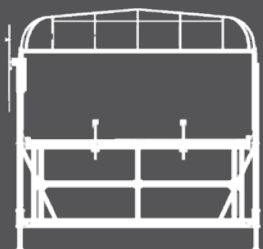
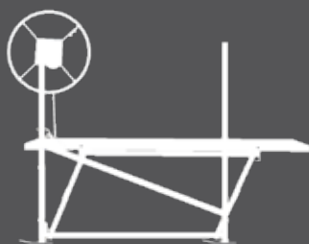

## *benefits*

### VERSATILITY

The middle bunks for the tri-toon are adjustable to perfectly position your tri-toon on the lift.

### PREMIUM PROTECTION

Tri-toon vinyl covered bunks offer non-marring protection and even weight distribution providing superior protection for your tri-toon.

### SUPERIOR SUPPORT

Available exclusively for ShoreMaster's Pontoon Lifts the wider, longer frames provide better support for today's tri-toon.



# HYDRAULIC LIFT

EASY. REFINED. PUSH BUTTON OPERATION.



WIDE ARRAY  
OF AVAILABLE  
ACCESSORIES

## *benefits*

### **EASY OPERATION**

Remote control operation is standard with all hydraulic lifts for easy, convenient lift operation.

### **PREMIUM PERFORMANCE**

Welded construction provides superior durability over bolt-together lifts, with easier assembly and installation.

### **EASY OWNERSHIP**

Traditional hydraulic design requires minimal maintenance, making it easy to own.

### **ENDLESS VERSATILITY**

Lift rack beams can accommodate bunks, guides, and other accessories to fit any style of watercraft.

### **SUPERIOR DURABILITY**

The premium hydraulic pump is designed for simple, reliable operation and is housed in an attractive fiberglass box.



# HYDRAULIC LIFT

## LIFT AND ACCESSORIES

### MODELS AND SPECIFICATIONS

#### HYDRAULIC LIFT ▲

MODEL	WEIGHT CAPACITY	INSIDE LEG WIDTH	BACK HEIGHT	STANDARD LEG LENGTH	OVERALL WIDTH	OVERALL LENGTH	CANOPY LENGTH	NET PRICE
4948	4,000 lbs.	108"	48"	36"	120"	124"	21'-29'	\$8,525.00
4960	4,000 lbs.	108"	60"	36"	120"	124"	21'-29'	\$8,729.00
41048	4,000 lbs.	120"	48"	36"	132"	124"	23'-33'	\$8,629.00
4160	4,000 lbs.	120"	60"	36"	132"	124"	23'-33'	\$8,759.00
6948	6,000 lbs.	108"	48"	36"	120"	124"	21'-29'	\$9,539.00
61048	6,000 lbs.	120"	48"	36"	132"	124"	23'-33'	\$9,799.00
6960	6,000 lbs.	108"	60"	36"	120"	124"	21'-29'	\$9,879.00
61060	6,000 lbs.	120"	60"	36"	132"	124"	23'-33'	\$10,439.00
81148	8,000 lbs.	132"	48"	36"	144"	168"	27'-35'	\$17,779.00
81160	8,000 lbs.	132"	60"	36"	144"	168"	27'-35'	\$18,349.00
101148	10,000 lbs.	132"	48"	36"	144"	192"	27'-35'	\$19,789.00
101160	10,000 lbs.	132"	60"	36"	144"	192"	27'-35'	\$20,789.00
1251160	12,000 lbs.	132"	60"	36"	144"	228"	27'-35'	\$26,889.00

#### 4000 and 6000 lb ACCESSORIES

#### NET PRICE

1013392	15' Extension Hose 25 x 15'	\$389.00
1015547	Hydraulic Box Holder Bracket for Lift (REQUIRES CANOPY ADAPTOR LEG)	\$149.00
1019388	Solar Panel for Hydraulic Box	\$279.00
1007319	Single Hydraulic Lift 84" Canopy Adaptor Leg	\$199.00
1001764	AC Charging kit (BATTERY NOT INCLUDED)	\$129.00
SMHYDOIL	Hydraulic Oil (QUART)	\$36.00
1006993	Full Length Carpeted/Wood Bunks 11' Brackets & Wood Repair (PAIR)	\$539.00
FLB	11' Full Length Aluminum/Vinyl Bunk	\$565.00
LAFUL50BK	14' Full Length Aluminum/Vinyl Bunk	\$899.00
GO	53" Guide-Ons Blue Log (SET OF 4)	\$609.00
FLG	11' Full Length Guide Aluminum/Carpeted Bunk	\$595.00
LAFUL50GD	14' Full Length Guide Aluminum/Carpeted Bunk	\$699.00
PRC	Pontoon Rail Kit Straight Rack	\$449.00
1007000	Tri-Caddy Hardware (3 TIRE WHEEL CADDY, TIRES PURCHASED SEPARATELY)	\$599.00
WADPW	Polyethylene Tires	\$105.00
BOWSTOP	Bow Guide	\$769.00

#### CANOPY ADAPTOR LEGS

1007319	Single C-7' Canopy Adaptor Leg	\$199.00
1006997	7' Canopy Adaptor Legs (SET OF 4)	\$599.00
1004221	9' Canopy Adaptor Legs (SET OF 4, RECOMMENDED ON LIFTS WITH 60" TRAVEL)	\$629.00

CANOPY ADAPTOR LEGS REQUIRED TO ADD CANOPY

**WARNING:** DRY BOAT WEIGHTS ARE OFTEN UNDERSTATED BY THE MANUFACTURER. ALSO THEY DO NOT INCLUDE GAS, GEAR, ETC. WEIGH YOUR BOAT FULLY LOADED TO GET ACCURATE WEIGHT. WARRANTY IS VOID IF THE LIFT CAPACITY IS EXCEEDED.



### EASY. REFINED. PUSH BUTTON OPERATION.

Featuring the latest technology, ShoreMaster's Hydraulic Lifts are solid, powerful, fast, and user friendly. They are a great solution for firm to slightly soft lake bottoms and moderately shallow to deeper water.

### MODELS AND SPECIFICATIONS

#### 8000, 10,000 and 12,000 lb ACCESSORIES

#### NET PRICE

1016926	Deep Water Brace for 8, 10 & 12K Hydraulic Lifts (BRACES 2 LEGS)	\$699.00
1004747	I-5 Leg Post (EACH) 3" x 3"	\$189.00
1004749	I-7 Leg Post (EACH) 3" x 3"	\$229.00
1004750	I-9 Leg Post (EACH) 3" x 3"	\$289.00

#### HEAVY ADAPTOR FLG POCKETS

1004219	Heavy Duty FLG Adaptor Pockets	\$385.00
1006986	14' Full Length Guide Aluminum/Carpeted Wood	\$699.00

10,000 & 12,000 HYDRAULICS REQUIRE HEAVY DUTY FLG ADAPTOR POCKETS

#### CANOPY ADAPTOR LEGS

1003745	Single I-7' Canopy Adaptor Leg	\$199.00
1004226	7' Canopy Adaptor Legs (SET OF 4)	\$789.00
1004225	9' Canopy Adaptor Legs (SET OF 4, RECOMMENDED ON LIFTS WITH 60" TRAVEL)	\$889.00

CANOPY ADAPTOR LEGS REQUIRED TO ADD CANOPY

▲ ALL HYDRAULIC LIFTS ARE SPECIAL ORDER

# HEAVY CAPACITY LIFT

## POWERFUL. TOUGH. BUILT TO LAST.

### MODELS AND SPECIFICATIONS

#### HEAVY CAPACITY LIFT SPECIFICATIONS

MODEL	WEIGHT CAPACITY	INSIDE WIDTH	LIFT HEIGHT	ACTUAL WEIGHT	OVERALL WIDTH	WINCH MODEL	CANOPY LENGTH	NET PACKAGE PRICE*
SM501066	5,000 lbs.	120"	66"	525 lbs.	132"	Whisper	25'-35'	\$8,199.00
SM601066	6,000 lbs.	120"	66"	575 lbs.	132"	Whisper	25'-35'	\$9,449.00
SM701066	7,000 lbs.	120"	68"	695 lbs.	134"	SM 7000	25'-35'	\$11,689.00

#### HEAVY CAPACITY LIFT ACCESSORIES

C5LEG	5' Boat Lift Leg	\$160.00
C7LEG	7' Boat Lift Leg	\$190.00
1004747	5' Boat Lift Leg (7,000 LBS.) 1-5 3" x3"	\$189.00
1004749	7' Boat Lift Leg (7,000 LBS.) 1-5 3" x3"	\$229.00
430015765	Easy Adjust Legs (PAIR)	\$529.00
WC	Wheel Caddy (PAIR)	\$789.00
BOWSTOP	Bow Guide	\$769.00
LADEPBRAC	Boat Lift Deep Water Brace (PAIR, SUPPORTS TWO LEGS)	\$299.00
<small>(NEEDED IF 5' OR MORE OF THE LIFT LEGS ARE EXTENDED OUT OF THE LIFT SIDES)</small>		
LAFU/50BK	14' Full Length Bunks for 5010 & 6010 DVS	\$899
LAFU/50GD	14' Full Length Guide Alum/Carpeted Wood for 5010 & 6010	\$699
MSV	Adjustable Motor Stop for V-Rack	\$199
LBWBL	ShoreMaster Large Blue Wheel for Boat Lifts	\$179
BOWSTOP7▲	Bow Guide for 7k	\$899
LAFU/70BK	14' Full Length Bunk for 7010 DVS	\$989
LAFU/70GD	14' Full Length Guide Alum/Carpeted Wood 7010 DVS	\$989

▲ SPECIAL ORDER LIFT

\*PACKAGE INCLUDES ASSEMBLY, FULL LENGTH BUNKS, FULL LENGTH GUIDES, AND MOTOR STOP.

**WARNING:** DRY BOAT WEIGHTS ARE OFTEN UNDERSTATED BY THE MANUFACTURER. ALSO THEY DO NOT INCLUDE GAS, GEAR, ETC. WEIGH YOUR BOAT FULLY LOADED TO GET ACCURATE WEIGHT. WARRANTY IS VOID IF THE LIFT CAPACITY IS EXCEEDED.



### POWERFUL. TOUGH. BUILT TO LAST.

ShoreMaster's Heavy Duty vertical lift is designed to work in shallow, deep or fluctuating water conditions. ShoreMaster's all aluminum welded construction provides a lightweight, maintenance free lift for greater strength and durability.

The double V-Side design allows for easy access to both sides of your boat. These lifts provide safe, secure mooring with virtually maintenance free operation.

# PWC LIFTS

CUSTOMIZABLE. SOLID. FULLY ADJUSTABLE.

## MODELS AND SPECIFICATIONS

### VERTICAL PWC LIFT

Model	Description	NET PACKAGE PRICE*
SM1264	Vertical Personal Watercraft Lift and Carpeted Bunks (PAIR)	\$1,995.00

### CANTILEVER PWC LIFT

SM1264CANT	Cantilever Personal Watercraft Lift and Carpeted Bunks (PAIR)	\$1,599.00
------------	---	------------



## benefits

### BUILT TO LAST

We stand by our 15 year Structural Warranty, including the welds.

### SOLID MATERIALS

Made of stainless steel cable and an all aluminum wheel with ball bearing knob.

### CUSTOMIZABLE

Both PWC Lifts feature four fully adjustable legs and have a canopy option available.

### WEIGHT CAPACITY

Both PWC Lifts have a weight capacity of 1,200 lbs. and a maximum beam of 64".



CANTILEVER PWC LIFT



VERTICAL PWC LIFT

\*PACKAGE INCLUDES ASSEMBLY AND 8" CARPETED BUNKS.

**WARNING:** DRY BOAT WEIGHTS ARE OFTEN UNDERSTATED BY THE MANUFACTURER. ALSO THEY DO NOT INCLUDE GAS, GEAR, ETC. WEIGH YOUR BOAT FULLY LOADED TO GET ACCURATE WEIGHT. WARRANTY IS VOID IF THE LIFT CAPACITY IS EXCEEDED.

## capacity

**MAX BEAM**

64"

**WEIGHT CAPACITY**

1,200 lbs.



FIREMASTER

220 SunSail



# CANOPIES & POWER UNITS

You look forward to spending time on the water with friends and family more than anything else. You want products that make it easier for you to get out on the water. Boat lift canopies and boat lift power units from ShoreMaster allow you the simple convenience of protection from the elements, while providing fast and easy boat lift operation. When it's easier for you to use and store your boat, you'll find yourself spending more time enjoying it with friends and family. Get more time on the water with your family and a lot less stress when you choose the convenience and quality of a ShoreMaster canopy or boat lift power unit.



**SHOREMASTER**

VLX

malibu

malibu



# CANOPY COVERS

CHOOSE YOUR SIZE, STYLE, AND COLOR

## 13oz VINYL WITH TOP COAT

DURABLE | LIGHT WEIGHT | PROTECTION | EASY INSTALLATION

ShoreMaster's premium 13oz vinyl canopy cover with top coat allows you to enjoy your boat at a moment's notice without the need to unsnap a boat cover or clean and dry the interior.

The 13oz vinyl canopy cover with top coat is designed to be very lightweight without sacrificing the durability or moisture and UV protection that you expect from a premium vinyl canopy cover. Your OEM exclusive top coated vinyl canopy cover will outperform heavier 18oz vinyls in the following areas: tear resistance, grab tensile, strip tensile and hydrostatic resistance.

## VINYL OPTIONS



## WEATHERMAX®

LIGHT WEIGHT | PROTECTION | COLOR RETENTION | EASY INSTALLATION

ShoreMaster's WeatherMax® fabric canopy covers offer superior protection from the elements. You'll enjoy WeatherMax's ease-of-use when it comes to installation, removal or storage of the cover because WeatherMax® is incredibly lightweight and easy to handle.

WeatherMax® canopy covers feature a water repellent HydroMax™ finish for long lasting protection, durability, color retention and superior protection from the elements. Choose from either the traditional canopy frame or the hip-roof canopy frame.

## WEATHERMAX® OPTIONS



# TRADITIONAL CANOPY

YOUR BOAT. YOUR INVESTMENT. PROTECT IT.



## TRADITIONAL CANOPY

DURABLE | DEEP FRAME | SUPERIOR COVERAGE

A traditional canopy from ShoreMaster will keep your boat clean, dry and ready for adventure while helping to maintain its value year after year.

ShoreMaster's traditional canopy provides strength and features hand welding to reduce maintenance.

A deep, rounded design with a shallow pitch allows you to tuck your boat completely into the frame for superior protection from sun and wind driven rain.

ShoreMaster's vented ends provide breathability to inhibit the buildup of mold and mildew.



# TRADITIONAL CANOPY

## CANOPY AND ACCESSORIES



### MODELS AND SPECIFICATIONS

#### TRADITIONAL CANOPY FRAME LESS LEGS

		NET PRICE
1055CFRAME	10' x 55" Less Legs	\$649.00
10110CFRAME	10' x 110" Less Legs	\$899.00
1364CFRAME	13' x 64" Less Legs (1264 VERTICAL)	\$799.00
1984CFRAME	19' x 84" Less Legs (1284 CANTILEVER)	\$1,174.00
2196CFRAME	21' x 96" Less Legs	\$1,199.00
21108CFRAME	21' x 108" Less Legs	\$1,429.00
23100CFRAME	23' x 100" Less Legs	\$1,459.00
23108CFRAME *	23' x 108" Less Legs	\$1,529.00
23120CFRAME	23' x 120" Less Legs	\$1,589.00
25108CFRAME	25' x 108" Less Legs	\$1,629.00
25120CFRAME *	25' x 120" Less Legs	\$1,709.00
27108CFRAME	27' x 108" Less Legs (INCLUDES CANOPY BRACE)	\$2,089.00
27120CFRAME	27' x 120" Less Legs (INCLUDES CANOPY BRACE)	\$2,179.00
27132CFRAME	27' x 132" Less Legs (INCLUDES CANOPY BRACE)	\$2,349.00
29120CFRAME *	29' x 120" Less Legs (INCLUDES CANOPY BRACE)	\$2,269.00
29132CFRAME	29' x 132" Less Legs (INCLUDES CANOPY BRACE)	\$2,399.00
31120CFRAME	31' x 120" Less Legs (INCLUDES CANOPY BRACE)	\$2,379.00
31132CFRAME	31' x 132" Less Legs (INCLUDES CANOPY BRACE)	\$2,499.00
33120CFRAME	33' x 120" Less Legs (INCLUDES CANOPY BRACE)	\$2,499.00
33132CFRAME	33' x 132" Less Legs (INCLUDES CANOPY BRACE)	\$2,889.00
35132CFRAME	35' x 132" Less Legs (INCLUDES CANOPY BRACE)	\$3,699.00

#### TRADITIONAL CANOPY LEG BUNDLES

15GLEG	1.5 G Canopy Leg Bundle (4 PER BUNDLE FITS 1055 & 1055 ADD-ON)	\$179.00
3BLEG	3-B Canopy Leg Bundle (2 PER BUNDLE 1-1/8" X 1-5/8" FITS 1200 CANTILEVER LIFTS)	\$81.00
3HLEG	3-H Canopy Leg Bundle (2 PER BUNDLE 2" X 2" FITS 1264 & 20855 VERTICAL)	\$91.00
3ALEG	3-A Canopy Leg Bundle (2 PER BUNDLE 1-7/16" X 1-15/16 FITS 2096, 25108, 25120, REAR LEGS OF 36108)	\$91.00
3CLEG *	3-C Canopy Leg Bundle (4 PER BUNDLE 2-1/2" X 2-1/2" FITS 3-4-5 VERTICALS & CANTILEVERS)	\$229.00
3DLEG	3-D Canopy Leg Bundle (2 PER BUNDLE 1-1/2" X 4" FITS FRONT LEGS 36108 CANTILEVER)	\$129.00
41LEG	4-1 Canopy Leg Bundle (2 PER BUNDLE 3" X 3" FITS 701068 VERTICAL)	\$153.00
5CLEG *	5-C Canopy Leg (SOLD AS EACH) (2-1/2" X 2-1/2" FITS 3-4-5 VERTICALS AND CANTILEVERS)	\$89.00

#### TRADITIONAL CANOPY FRAME BRACE

CANOPYBRACE	Canopy Brace (PAIR)	\$359.00
-------------	---------------------	----------

#### LIFT LOFT

96LIFTLOFT	Lift Loft for 96" and smaller	\$199.00
108LIFTLOFT	Lift Loft for 108" and larger	\$199.00
120LIFTLOFT	Lift Loft for 120" and larger	\$199.00

\*IN-STOCK

### MODELS AND SPECIFICATIONS

#### TRADITIONAL CANOPY COVERS

SIZE	VINYL	WEATHERMAX®
10' x 55"	\$649.00	\$739.00
10' x 110"	\$789.00	\$909.00
13' x 64"	\$739.00	\$899.00
19' x 84"	\$879.00	\$1,129.00
21' x 96"	\$999.00	\$1,269.00
21' x 108"	\$1049.00	\$1,349.00
23' x 108"	\$1079.00	\$1,399.00
23' x 100"	\$1099.00	\$1,399.00
23' x 120"	\$1129.00	\$1,449.00
25' x 108"	\$1169.00	\$1,489.00
25' x 120"	\$1189.00	\$1,529.00
27' x 108"	\$1249.00	\$1,609.00
27' x 120"	\$1299.00	\$1,619.00
29' x 120"	\$1479.00	\$1,809.00
31' x 120"	\$1649.00	\$1,939.00
33' x 120"	\$1729.00	\$2,059.00
27' x 132"	\$1759.00	\$2,409.00
29' x 132"	\$1969.00	\$2,699.00
31' x 132"	\$2079.00	\$2,999.00
33' x 132"	\$2149.00	\$3,109.00
35' x 132"	\$2449.00	\$3,539.00

#### CANOPY FRAME SKIRT EXTENSION\*

#### NET PRICE

25'	Canopy Skirt Extension Frame	\$939.00
27'	Canopy Skirt Extension Frame	\$959.00
29'	Canopy Skirt Extension Frame	\$989.00
25'-27'	Canopy Skirt 13oz Vinyl Cover	\$1,099.00
29'	Canopy Skirt 13oz Vinyl Cover	\$1,199.00
25'-27'	Canopy Skirt WeatherMax® Cover	\$1,169.00
29'	Canopy Skirt WeatherMax® Cover	\$1,269.00

\*SEE PHOTO ABOVE  
(ADDS 50" OF DROP TO CANOPY FRAME ON 2 SIDES & 1 END)

# HIP ROOF CANOPY

YOUR BOAT. YOUR INVESTMENT. PROTECT IT.



## HIP ROOF CANOPY

CLEAN LINES | ATTRACTIVE STYLE  
SHALLOW PITCH

ShoreMaster's hip roof canopy frame is designed to provide superior protection for your boat with clean, modern lines.

The pitch of ShoreMaster's hip roof canopy helps to shed rain and moisture while its welded construction makes it incredibly durable and easy to maintain.

The hip roof canopy features a lower profile than traditional canopy frames, offering premium protection without sacrificing lakefront aesthetics.



# HIP ROOF CANOPY

## CANOPY FRAME AND ACCESSORIES

### MODELS AND SPECIFICATIONS

#### HIP ROOF CANOPIES

	NET PRICE
24' X 108" Hip Roof Canopy, Less Legs	\$1,479.00
26' X 108" Hip Roof Canopy, Less Legs (INCLUDES CANOPY BRACE)	\$1,749.00
28' X 108" Hip Roof Canopy, Less Legs (INCLUDES CANOPY BRACE)	\$1,849.00
24' X 120" Hip Roof Canopy, Less Legs	\$1,499.00
26' X 120" Hip Roof Canopy, Less Legs (INCLUDES CANOPY BRACE)	\$1,799.00
28' X 120" Hip Roof Canopy, Less Legs (INCLUDES CANOPY BRACE)	\$1,869.00

#### HIP ROOF CANOPY LEGS

3' Hip Roof Canopy Legs (SET OF FOUR LEGS)	\$239.00
5' Hip Roof Canopy Legs (SET OF FOUR LEGS)	\$369.00
7' Hip Roof Canopy Legs (SET OF FOUR LEGS)	\$519.00

### MODELS AND SPECIFICATIONS

#### HIP ROOF CANOPY COVERS

SIZE	VINYL	WEATHERMAX®
24' X 108"	\$969.00	\$1,129.00
26' X 108"	\$989.00	\$1,239.00
28' X 108"	\$1,039.00	\$1,279.00
24' X 120"	\$1,099.00	\$1,209.00
26' X 120"	\$1,129.00	\$1,349.00
28' X 120"	\$1,159.00	\$1,389.00

**⚠ ALL HIP ROOF CANOPIES AND ACCESSORIES ARE SPECIAL ORDER**





**MASTER**  
**OUT**

• A combination of electrical and mechanical components are used in the outboard motor. The outboard motor is a complex piece of machinery and should be handled with care. It is not to be used as a tool or for any other purpose. It is not to be used in a way that could cause damage to the outboard motor or the boat.

• The outboard motor should be stored in a dry, well-ventilated area. It should be stored in a way that will prevent damage to the outboard motor.

• The outboard motor should be stored in a way that will prevent damage to the outboard motor.

**CAUTION:** This outboard motor is a complex piece of machinery and should be handled with care. It is not to be used as a tool or for any other purpose. It is not to be used in a way that could cause damage to the outboard motor or the boat.

www.mastercraft.com  
 1-800-4-A-MOTOR  
 1-800-4-AMOTOR  
 1-800-4-AMOTOR



# BOAT LIFT POWER UNIT

EASY INSTALLATION. EASIER OPERATION.

## LIFT MATE™

EASY INSTALLATION | SIMPLE TO USE | UNIVERSAL DESIGN

You want a boat lift power unit that is easy to install, easy to operate, and won't let you down when it's time to take your boat for a cruise or when you return from time spent on the water. The Lift Mate™ provides you with all of that with a universal design that is perfect for new or existing boat lifts.

Available in 110V and 12V models that feature easy-to-use toggle switch operation. Mounting hardware is included to fit boat lifts up to 5,000 lbs.

### AVAILABLE OPTIONS:

- 110V or 12V



## LIFT BOSS™

DEPENDABLE | QUIET OPERATION | EASY TO INSTALL

Add enjoyment to your time spent on the water with ShoreMaster's Lift Boss™ boat lift power unit. The Lift Boss™ is the quickest and easiest way to upgrade your ShoreMaster boat lift to add the convenience of motorized boat lift operation. The Lift Boss is incredibly easy to install, easy to use and it's designed to perform flawlessly season after season.

### AVAILABLE OPTIONS:

- 120V or 12/24V
- Key-turn and Wireless Remote Operation

### AVAILABLE ACCESSORIES:

- Solar Panel
- Battery Tray



## *benefits*

### EASY INSTALLATION

Installs quickly and easily with simple hand tools for a quick boat lift upgrade.

### SIMPLE TO USE

Simply push the toggle switch to effortlessly raise or lower your boat lift.

### POWER OPTIONS

12V or 110V options to fit your waterfront property's power availability.

### 20-MINUTE INSTALLATION

Included in the Lift Boss™ boat lift power unit is the mounting kit for your ShoreMaster Whisper Winch™.

### EASY OPERATION

All models include easy key-turn operation. For additional ease-of-use choose the wireless remote operation.

### POWER OPTIONS

12/24V or 110V to fit your waterfront property's power availability.

# BOAT LIFT POWER UNIT

## POWER UNITS AND ACCESSORIES

### MODELS AND SPECIFICATIONS

LIFT MATE™		NET PRICE
ACPU	Lift Mate™ 110V Boat Lift Power Unit	\$959.00
DCPU	Lift Mate™ 12V Boat Lift Power Unit	\$959.00
LIFT BOSS™		
BLBOSS120	Lift Boss™ 120V Boat Lift Power Unit	\$1,395.00
BLBOSS1224	Lift Boss™ 12/24V Boat Lift Power Unit	\$1,395.00
LIFT BOSS™ ACCESSORIES		
SOLARPANEL10W	Solar Panel 10 Watt W/Bracket and Hardware Kit	\$299.00
BATTRAY	Battery Tray Complete	\$129.00
BATTRAYCAN	Battery Tray Kit Canopy Mount	\$159.00
24VSPKIT	24V Solar Panel w/ Mounting Kit	\$429.00
24VBATTRAY	24V Battery Box Tray Kit - Canopy Mount	\$209.00
LBWE5	ShoreMaster Lift Boss™ Wire Extension 5'	\$99.00
LBWE10	ShoreMaster Lift Boss™ Wire Extension 10'	\$129.00
LBWE15	ShoreMaster Lift Boss™ Wire Extension 15'	\$149.00
LBCLK	ShoreMaster Lift Boss™ Canopy Light Kit	\$99.00
24VJW12	ShoreMaster Jumper Wire for 24V Installation - 12"	\$49.00
24VJW24	ShoreMaster Jumper Wire for 24V Installation - 24"	\$59.00
LBECB	ShoreMaster Lift Boss™ 24v Connect - Ease Bridge Connector	\$129.00
24VTMBATTRAY	24V Battery Box Tray Kit - Top Mount	\$159.00
LBKFR	Lift Boss™ FOB Remote (Red)	\$85.00
LBRK	Lift Boss™ Replacement Key	\$15.00
DOCK BOXES		
4CDBOXW	4' Corner Dock Box - White	\$399.00
4CDBOXG	4' Corner Dock Box - Gray	\$399.00

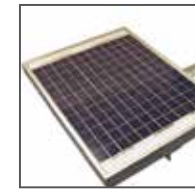

#### SOLAR PANEL KIT

Harness the power of the sun to charge your boat lift power unit for easy, convenient lift operation.



#### CORNER DOCK BOX

Need extra storage? ShoreMaster's corner dock boxes will meet the challenge. Great for storing your lifejackets, ski ropes, etc. The all poly construction means no maintenance. Engineered to fit on the corner of most docks, these attractive dock boxes measure 4' x 28.5". Available in white and gray.



#### BATTERY TRAY

Leg mount or canopy mount options available. For use with 12V or 24V boat lift power unit.



# DELIVERY FEES

GOING THE EXTRA MILE.

Hammond Lumber Company is the **LARGEST DISTRIBUTOR in the COUNTRY**



## *delivery fees*

- FREE DELIVERY
- \$200 DELIVERY FEE
- \$375 DELIVERY FEE
- \$450 DELIVERY FEE
- \$600 DELIVERY FEE
- ★ HAMMOND LUMBER COMPANY LOCATION

**Hammond**  
**Lumber Company**

# SHOREMASTER WARRANTY

## *Top Notch Protection.*

ShoreMaster, LLC warrants all ShoreMaster brand aluminum docks and lifts purchased new by the original owner to be free from defects for a period of 15 years and an eight-year warranty applies to the PolyDock. A five-year prorated warranty applies to canopy covers and a ten-year warranty applies to polyethylene floats. A two-year warranty covers the remaining components of these products (excluding components and options which carry their own manufacturer's warranty, wherein that warranty will apply).

ShoreMaster will, at its option, repair or replace, without charge, or allow credit for any such goods found on examination by ShoreMaster to be defective under normal use and service, provided ShoreMaster is promptly notified in writing upon discovery of such defects. The buyer's remedies with respect to defective goods shall be exclusively limited as above provided and in no event shall ShoreMaster or Hammond Lumber Company be liable for incidental or consequential damages of any nature. All repair work must be done by a registered ShoreMaster dealer.

This warranty does not cover damage caused by improper use, installation, overloading, accident, neglect or harmful alterations or repairs made by others, damage by snow or ice, electrolysis, severe weather conditions and Acts of God.





## WHY HAMMOND LUMBER COMPANY?

### LARGE INVENTORY

Hammond is the largest stocking distributor of ShoreMaster products in the United States. Some competitors' systems take 4-6 weeks to manufacture and deliver. Most ShoreMaster items are in stock at all of Hammond's thirteen convenient locations.

### FAST DELIVERY

Hammond offers delivery anywhere in Maine usually within 24 hours. Delivery anywhere in the eastern United States and Canada can also be arranged.

### VALUE

Hammond purchases full truckloads of product which enables them to pass on these savings to its customers. A ShoreMaster system is a sensible, long term solution to waterfront equipment.

### MAINTENANCE FREE

Aluminum components provide a maintenance free, long lasting waterfront system. ShoreMaster dock frames, dock legs and ladders are made of high quality aluminum — not galvanized steel like some competitors.

### INSTALLATION

Hammond has a large network of installers available who install and remove ShoreMaster waterfront systems. We will assist you in finding someone who will best fit your individual needs and requirements.

### WARRANTY

ShoreMaster backs their residential waterfront products with a 15-year warranty on the aluminum structure and welds. A two-year warranty covers the remaining components of these products.

### ADAPTABILITY

ShoreMaster's "Universal Dock System" allows for configuration flexibility and future expansion. Configuration changes and additions are easily accommodated by a unique ShoreMaster design.

### BRAND NAME

ShoreMaster is a nationally recognized company. ShoreMaster products carry a re-sale value much better than competitor products.

# DESIGN YOUR DOCK

SEE OUR ONLINE DOCK BUILDER AT [HAMMONDLUMBER.COM](http://HAMMONDLUMBER.COM)

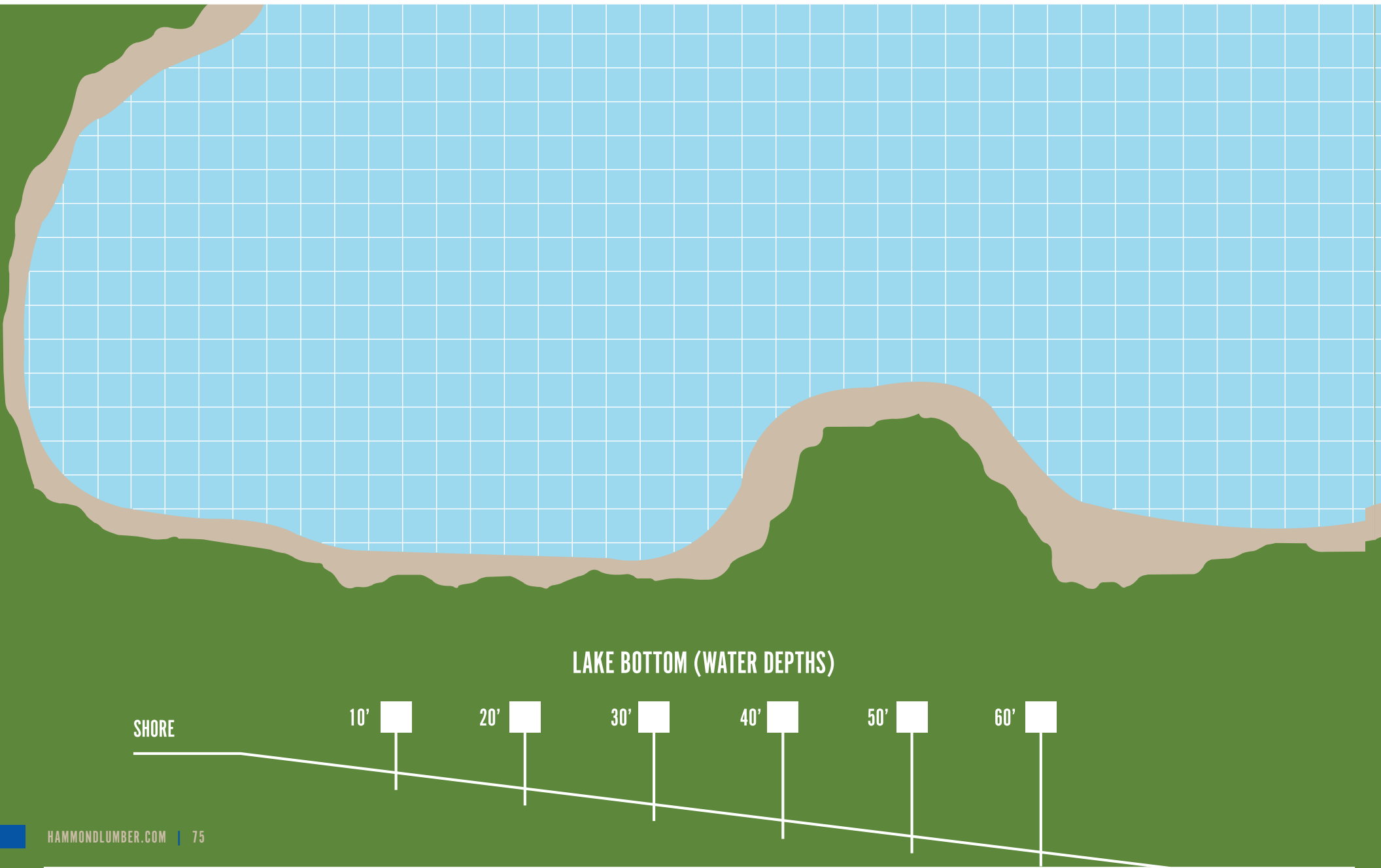

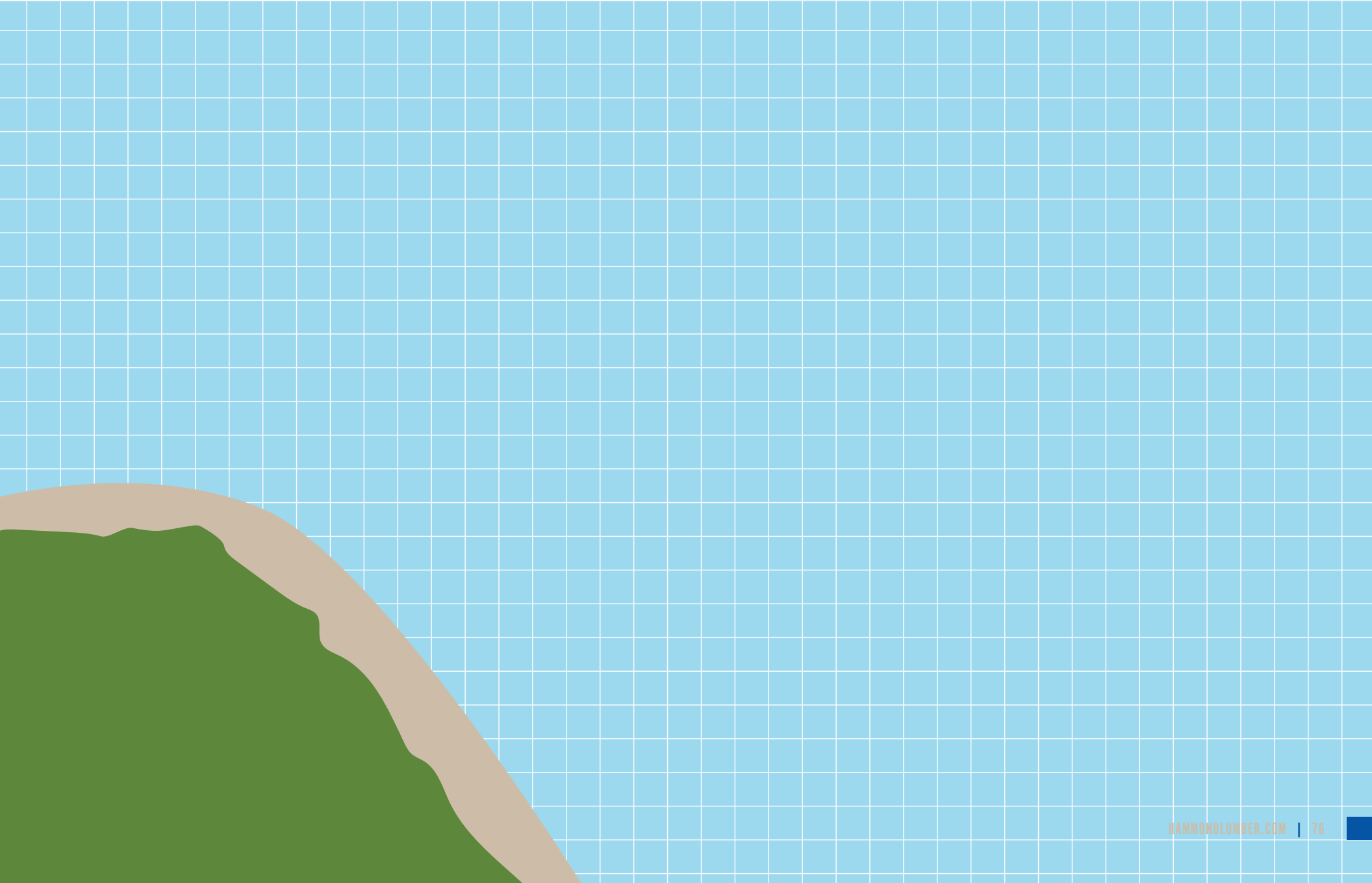

# DOCK SPECIFICATIONS

CHOOSING THE RIGHT PRODUCT HAS NEVER BEEN SO EASY

## INFINITY RS4 P. 14-18



SIZE	WEIGHT
4'X4'	52 lbs
4'X10'	82 lbs
4'X12' *	97 lbs
6'X8'	90 lbs
3' CORNER	20 lbs
45°	33 lbs
90°	36 lbs

### INFINITY RS4 ACCESSORIES AVAILABLE NOT AVAILABLE

- |  |   |  |  |
|--|---|--|--|
| <input checked="" type="checkbox"/> 5-SIDE DOCK LEGS(TM) & POCKETS | <input type="checkbox"/> L-BRACES                         | <input checked="" type="checkbox"/> QC FISHING POLE HOLDER | <input checked="" type="checkbox"/> QC UMBRELLA HOLDER   |
| <input checked="" type="checkbox"/> CLEATS                         | <input type="checkbox"/> POLY TIRES                       | <input checked="" type="checkbox"/> QC FLAGPOLE HOLDER     | <input checked="" type="checkbox"/> RAMP ROLLER KIT      |
| <input checked="" type="checkbox"/> CONVERSION KITS                | <input checked="" type="checkbox"/> QC BOAT LIFT HANDRAIL | <input checked="" type="checkbox"/> QC HANDRAIL            | <input checked="" type="checkbox"/> SCREW LEGS           |
| <input checked="" type="checkbox"/> DOCK LEG CAPS                  | <input checked="" type="checkbox"/> QC CANOE/KAYAK RACK   | <input checked="" type="checkbox"/> QC PIVOT LADDER        | <input type="checkbox"/> SHORE-END WHEEL KIT             |
| <input checked="" type="checkbox"/> GANGWAYS                       | <input checked="" type="checkbox"/> QC DOCK BENCH         | <input type="checkbox"/> QC PIPE BRACKETS                  | <input checked="" type="checkbox"/> TELESCOPING FLAGPOLE |
| <input checked="" type="checkbox"/> HINGES                         | <input checked="" type="checkbox"/> QC DOCK BUMPERS       | <input checked="" type="checkbox"/> QC QUICK STEPS         | <input type="checkbox"/> WHEEL-AXLE ADAPTER              |
| <input type="checkbox"/> INFINITY CATERPILLAR CLIP                 | <input checked="" type="checkbox"/> QC DOCK FURNITURE     | <input checked="" type="checkbox"/> QC RAMP                | <input checked="" type="checkbox"/> WINCH LEVELING KIT   |
| <input checked="" type="checkbox"/> L-ADAPTERS                     | <input checked="" type="checkbox"/> QC DOCK STEPS         | <input type="checkbox"/> QC TOW HITCH                      | <input type="checkbox"/> FTS9 CHAIN ANCHOR KIT           |

## INFINITY RS7 P. 20-24



SIZE	WEIGHT
4'X8'	80 lbs
4'X16'	131 lbs
6'X8' *	97 lbs
6'X16' *	155 lbs
3' CORNER	28 lbs

### INFINITY RS4 ACCESSORIES AVAILABLE NOT AVAILABLE

- |  |   |  |  |
|--|---|--|--|
| <input checked="" type="checkbox"/> 5-SIDE DOCK LEGS(TM) & POCKETS | <input checked="" type="checkbox"/> L-BRACES              | <input checked="" type="checkbox"/> QC FISHING POLE HOLDER | <input checked="" type="checkbox"/> QC UMBRELLA HOLDER   |
| <input checked="" type="checkbox"/> CLEATS                         | <input checked="" type="checkbox"/> POLY TIRES            | <input checked="" type="checkbox"/> QC FLAGPOLE HOLDER     | <input checked="" type="checkbox"/> RAMP ROLLER KIT      |
| <input checked="" type="checkbox"/> CONVERSION KITS                | <input checked="" type="checkbox"/> QC BOAT LIFT HANDRAIL | <input checked="" type="checkbox"/> QC HANDRAIL            | <input checked="" type="checkbox"/> SCREW LEGS           |
| <input checked="" type="checkbox"/> DOCK LEG CAPS                  | <input checked="" type="checkbox"/> QC CANOE/KAYAK RACK   | <input checked="" type="checkbox"/> QC PIVOT LADDER        | <input checked="" type="checkbox"/> SHORE-END WHEEL KIT  |
| <input checked="" type="checkbox"/> GANGWAYS                       | <input checked="" type="checkbox"/> QC DOCK BENCH         | <input type="checkbox"/> QC PIPE BRACKETS                  | <input checked="" type="checkbox"/> TELESCOPING FLAGPOLE |
| <input checked="" type="checkbox"/> HINGES                         | <input checked="" type="checkbox"/> QC DOCK BUMPERS       | <input checked="" type="checkbox"/> QC QUICK STEPS         | <input type="checkbox"/> WHEEL-AXLE ADAPTER              |
| <input checked="" type="checkbox"/> INFINITY CATERPILLAR CLIP      | <input checked="" type="checkbox"/> QC DOCK FURNITURE     | <input checked="" type="checkbox"/> QC RAMP                | <input checked="" type="checkbox"/> WINCH LEVELING KIT   |
| <input checked="" type="checkbox"/> L-ADAPTERS                     | <input checked="" type="checkbox"/> QC DOCK STEPS         | <input checked="" type="checkbox"/> QC TOW HITCH           | <input type="checkbox"/> FTS9 CHAIN ANCHOR KIT           |

\*SPECIAL-ORDER

# DOCK SPECIFICATIONS

CHOOSING A DOCK HAS NEVER BEEN SO EASY

## INFINITY TS9 P. 30-32



SIZE	WEIGHT
4'X8'	61 lbs
4'X16'	102 lbs
6'X8' *	77 lbs
6'X16' *	125 lbs
3' CORNER	19 lbs

### INFINITY TS9 ACCESSORIES AVAILABLE NOT AVAILABLE

- |  |   |  |  |
|--|---|--|--|
| <input checked="" type="checkbox"/> 5-SIDE DOCK LEGS(TM) & POCKETS | <input checked="" type="checkbox"/> L-BRACES              | <input checked="" type="checkbox"/> QC FISHING POLE HOLDER | <input checked="" type="checkbox"/> QC UMBRELLA HOLDER   |
| <input checked="" type="checkbox"/> CLEATS                         | <input checked="" type="checkbox"/> POLY TIRES            | <input checked="" type="checkbox"/> QC FLAGPOLE HOLDER     | <input checked="" type="checkbox"/> RAMP ROLLER KIT      |
| <input checked="" type="checkbox"/> CONVERSION KITS                | <input checked="" type="checkbox"/> QC BOAT LIFT HANDRAIL | <input checked="" type="checkbox"/> QC HANDRAIL            | <input checked="" type="checkbox"/> SCREW LEGS           |
| <input checked="" type="checkbox"/> DOCK LEG CAPS                  | <input checked="" type="checkbox"/> QC CANOE/KAYAK RACK   | <input checked="" type="checkbox"/> QC PIVOT LADDER        | <input checked="" type="checkbox"/> SHORE-END WHEEL KIT  |
| <input checked="" type="checkbox"/> GANGWAYS                       | <input checked="" type="checkbox"/> QC DOCK BENCH         | <input type="checkbox"/> QC PIPE BRACKETS                  | <input checked="" type="checkbox"/> TELESCOPING FLAGPOLE |
| <input checked="" type="checkbox"/> HINGES                         | <input checked="" type="checkbox"/> QC DOCK BUMPERS       | <input checked="" type="checkbox"/> QC QUICK STEPS         | <input checked="" type="checkbox"/> WHEEL-AXLE ADAPTER   |
| <input checked="" type="checkbox"/> INFINITY CATERPILLAR CLIP      | <input checked="" type="checkbox"/> QC DOCK FURNITURE     | <input checked="" type="checkbox"/> QC RAMP                | <input checked="" type="checkbox"/> WINCH LEVELING KIT   |
| <input checked="" type="checkbox"/> L-ADAPTERS                     | <input checked="" type="checkbox"/> QC DOCK STEPS         | <input checked="" type="checkbox"/> QC TOW HITCH           | <input type="checkbox"/> FTS9 CHAIN ANCHOR KIT           |

## FLOATING FTS9 P. 38-40



SIZE	WEIGHT
2'X4' *	21 lbs
4'X4' *	30 lbs
4'X8'	61 lbs
4'X16'	102 lbs
6'X8' *	62 lbs
6'X16' *	122 lbs
3' CORNER	19 lbs

### FLOATING FTS9 ACCESSORIES AVAILABLE NOT AVAILABLE

- |   |   |  |   |
|---|---|--|---|
| <input type="checkbox"/> 5-SIDE DOCK LEGS(TM) & POCKETS | <input type="checkbox"/> L-BRACES                         | <input checked="" type="checkbox"/> QC FISHING POLE HOLDER | <input checked="" type="checkbox"/> QC UMBRELLA HOLDER    |
| <input checked="" type="checkbox"/> CLEATS              | <input type="checkbox"/> POLY TIRES                       | <input checked="" type="checkbox"/> QC FLAGPOLE HOLDER     | <input checked="" type="checkbox"/> RAMP ROLLER KIT       |
| <input type="checkbox"/> CONVERSION KITS                | <input checked="" type="checkbox"/> QC BOAT LIFT HANDRAIL | <input checked="" type="checkbox"/> QC HANDRAIL            | <input type="checkbox"/> SCREW LEGS                       |
| <input type="checkbox"/> DOCK LEG CAPS                  | <input checked="" type="checkbox"/> QC CANOE/KAYAK RACK   | <input checked="" type="checkbox"/> QC PIVOT LADDER        | <input type="checkbox"/> SHORE-END WHEEL KIT              |
| <input checked="" type="checkbox"/> GANGWAYS            | <input checked="" type="checkbox"/> QC DOCK BENCH         | <input checked="" type="checkbox"/> QC PIPE BRACKETS       | <input checked="" type="checkbox"/> TELESCOPING FLAGPOLE  |
| <input checked="" type="checkbox"/> HINGES              | <input checked="" type="checkbox"/> QC DOCK BUMPERS       | <input type="checkbox"/> QC QUICK STEPS                    | <input type="checkbox"/> WHEEL-AXLE ADAPTER               |
| <input type="checkbox"/> INFINITY CATERPILLAR CLIP      | <input checked="" type="checkbox"/> QC DOCK FURNITURE     | <input checked="" type="checkbox"/> QC RAMP                | <input type="checkbox"/> WINCH LEVELING KIT               |
| <input type="checkbox"/> L-ADAPTERS                     | <input type="checkbox"/> QC DOCK STEPS                    |  | <input checked="" type="checkbox"/> FTS9 CHAIN ANCHOR KIT |

\*SPECIAL-ORDER

# ALUMINUM LIFT SPECIFICATIONS

CHOOSING THE RIGHT PRODUCT HAS NEVER BEEN SO EASY

## VERTICAL P. 51-52



MODEL	CAPACITY	INSIDE WIDTH	LIFT TRAVEL/ HEIGHT	STD. LEG LENGTH	OVERALL WIDTH	OVERALL LENGTH	WINCH MODEL	CANOPY LENGTH
1264 SR-PWC	1200 lbs	64"	50"	24"	72"	80"	DL 1202	13'
2208 SR*	2200 lbs	96"	66"	36"	108"	127"	141 WHISPER	21'
3009 DVS	3000 lbs	108"	66"	36"	120"	127"	141 WHISPER	21'-27"
3010 DVS	3000 lbs	120"	66"	36"	132"	127"	141 WHISPER	23'-33"
4009 DVS	4000 lbs	108"	66"	36"	120"	127"	241 WHISPER	21'-27"
4010 DVS	4000 lbs	120"	66"	36"	132"	127"	241 WHISPER	23'-33"
5010 DVS	5000 lbs	120"	66"	36"	132"	127"	241 WHISPER	23'-33"
6010 DVS	6000 lbs	120"	66"	36"	132"	127"	241 WHISPER	23'-33"

### LIFT ACCESSORIES AVAILABLE NOT AVAILABLE

- BATTERY TRAY
- BOW GUIDE
- BUNKS
- CANOPY/CANOPY LEGS
- CRADLES
- DEEP WATER BRACES
- EXTENDED LEGS
- FULL LENGTH GUIDES
- HYDRAULIC BOX HOLDER
- LIFT ASSIST TOOL
- LIFT MOTORS
- MOTOR STOP
- POLY TIRES
- PONTOON MOTOR STOP
- PONTOON RACKS
- PONTOON RAIL KITS
- PVC GUIDES
- SCREW LEGS
- SOLAR PANEL
- UNI-CADDY
- TRI-/QUAD-CADDY

MODEL	CAPACITY	INSIDE WIDTH	LIFT TRAVEL/ HEIGHT	STD. LEG LENGTH	OVERALL WIDTH	OVERALL LENGTH	WINCH MODEL	CANOPY LENGTH
-------	----------	--------------	---------------------	-----------------	---------------	----------------	-------------	---------------

701068*	SR 7000 lbs	120"	66"	36"	132"	166"	SM 7000	23'-33'
---------	-------------	------	-----	-----	------	------	---------	---------

### LIFT ACCESSORIES AVAILABLE NOT AVAILABLE

- BATTERY TRAY
- BOW GUIDE
- BUNKS
- CANOPY/CANOPY LEGS
- CRADLES
- DEEP WATER BRACES
- EXTENDED LEGS
- FULL LENGTH GUIDES
- HYDRAULIC BOX HOLDER
- LIFT ASSIST TOOL
- LIFT MOTORS
- MOTOR STOP
- POLY TIRES
- PONTOON MOTOR STOP
- PONTOON RACKS
- PONTOON RAIL KITS
- PVC GUIDES
- SCREW LEGS
- SOLAR PANEL
- UNI-CADDY
- TRI-/QUAD-CADDY

## PONTOON P. 53-54



MODEL	CAPACITY	INSIDE WIDTH	LIFT TRAVEL/ HEIGHT	STD. LEG LENGTH	OVERALL WIDTH	OVERALL LENGTH	WINCH MODEL	CANOPY LENGTH
-------	----------	--------------	---------------------	-----------------	---------------	----------------	-------------	---------------

4010 PTN*	4000 lbs	120"	66"	36"	132"	175"	241 WHISPER	23'-33'
4010 DVS	4000 lbs	120"	66"	36"	132"	127"	241 WHISPER	23'-33'
5510 PTN*	5500 lbs	120"	66"	36"	132"	175"	241 WHISPER	23'-33'
701168 PTN*	7000 lbs	132"	68"	36"	144"	238"	SM 7000	27'-35'

### LIFT ACCESSORIES AVAILABLE NOT AVAILABLE

- BATTERY TRAY
- BOW GUIDE
- BUNKS
- CANOPY/CANOPY LEGS
- CRADLES
- DEEP WATER BRACES
- EXTENDED LEGS
- FULL LENGTH GUIDES
- HYDRAULIC BOX HOLDER
- LIFT ASSIST TOOL
- LIFT MOTORS
- MOTOR STOP
- POLY TIRES
- PONTOON MOTOR STOP
- PONTOON RACKS
- PONTOON RAIL KITS
- PVC GUIDES
- SCREW LEGS
- SOLAR PANEL
- UNI-CADDY
- TRI-/QUAD-CADDY

\*SPECIAL-ORDER



## CANTILEVER P. 55-56 (TO BE DISCONTINUED)



MODEL	CAPACITY	INSIDE WIDTH	LIFT TRAVEL/ HEIGHT	STD. LEG LENGTH	OVERALL WIDTH	OVERALL LENGTH	WINCH MODEL	CANOPY LENGTH
40108	4000 lbs	108"	40"	36"	120"	139"	141 WHISPER	23'-27"
40120*	4000 lbs	120"	40"	36"	132"	139"	141 WHISPER	23'-33"
50120*	5000 lbs	120"	40"	36"	132"	139"	241 WHISPER	23'-33"

### LIFT ACCESSORIES AVAILABLE NOT AVAILABLE

- |  |  |   |
|--|--|---|
| <input checked="" type="checkbox"/> BATTERY TRAY       | <input checked="" type="checkbox"/> FULL LENGTH GUIDES | <input checked="" type="checkbox"/> PONTOON RAIL KITS |
| <input checked="" type="checkbox"/> BOW GUIDE          | <input type="checkbox"/> HYDRAULIC BOX HOLDER          | <input checked="" type="checkbox"/> PVC GUIDES        |
| <input checked="" type="checkbox"/> BUNKS              | <input checked="" type="checkbox"/> LIFT ASSIST TOOL   | <input checked="" type="checkbox"/> SCREW LEGS        |
| <input checked="" type="checkbox"/> CANOPY/CANOPY LEGS | <input checked="" type="checkbox"/> LIFT MOTORS        | <input checked="" type="checkbox"/> SOLAR PANEL       |
| <input checked="" type="checkbox"/> CRADLES            | <input checked="" type="checkbox"/> MOTOR STOP         | <input checked="" type="checkbox"/> UNI-CADDY         |
| <input checked="" type="checkbox"/> DEEP WATER BRACES  | <input checked="" type="checkbox"/> POLY TIRES         | <input checked="" type="checkbox"/> TRI-/QUAD-CADDY   |
| <input checked="" type="checkbox"/> EXTENDED LEGS      | <input checked="" type="checkbox"/> PONTOON MOTOR STOP |   |
| <input type="checkbox"/> FLOAT PLANE PLATFORM          | <input checked="" type="checkbox"/> PONTOON RACKS      |   |

## HYDRAULIC P. 57-58



MODEL	CAPACITY	INSIDE WIDTH	LIFT TRAVEL/ HEIGHT	STD. LEG LENGTH	OVERALL WIDTH	OVERALL LENGTH	WINCH MODEL	CANOPY LENGTH
40948*	4,000 lbs	108"	48"	36"	120"	138"		21'-29"
40960*	4,000 lbs	108"	60"	36"	120"	138"		21'-29"
401048*	4,000 lbs	120"	48"	36"	132"	138"		23'-33"
401060*	4,000 lbs	120"	60"	36"	132"	138"		23'-33"
60948*	6,000 lbs	108"	48"	36"	120"	138"		21'-29"
601060*	6,000 lbs	120"	60"	36"	132"	138"		23'-33"
801148*	8,000 lbs	132"	48"	36"	144"	186"		27'-35"
801160*	8,000 lbs	132"	60"	36"	144"	186"		27'-35"

### LIFT ACCESSORIES AVAILABLE NOT AVAILABLE

- |  |  |   |
|--|--|---|
| <input type="checkbox"/> BATTERY TRAY                    | <input checked="" type="checkbox"/> FULL LENGTH GUIDES   | <input checked="" type="checkbox"/> PONTOON RAIL KITS |
| <input checked="" type="checkbox"/> BOW GUIDE            | <input checked="" type="checkbox"/> HYDRAULIC BOX HOLDER | <input checked="" type="checkbox"/> PVC GUIDES        |
| <input checked="" type="checkbox"/> BUNKS                | <input checked="" type="checkbox"/> LIFT ASSIST TOOL     | <input type="checkbox"/> SCREW LEGS                   |
| <input checked="" type="checkbox"/> CANOPY/CANOPY LEGS   | <input type="checkbox"/> LIFT MOTORS                     | <input checked="" type="checkbox"/> SOLAR PANEL       |
| <input checked="" type="checkbox"/> CRADLES              | <input checked="" type="checkbox"/> MOTOR STOP           | <input type="checkbox"/> UNI-CADDY                    |
| <input checked="" type="checkbox"/> DEEP WATER BRACES    | <input checked="" type="checkbox"/> POLY TIRES           | <input checked="" type="checkbox"/> TRI-/QUAD-CADDY   |
| <input checked="" type="checkbox"/> EXTENDED LEGS        | <input checked="" type="checkbox"/> PONTOON MOTOR STOP   |   |
| <input checked="" type="checkbox"/> FLOAT PLANE PLATFORM | <input checked="" type="checkbox"/> PONTOON RACKS        |   |

MODEL	CAPACITY	INSIDE WIDTH	LIFT TRAVEL/ HEIGHT	STD. LEG LENGTH	OVERALL WIDTH	OVERALL LENGTH	WINCH MODEL	CANOPY LENGTH
101148*	10,000 lbs	132"	48"	36"	149"	205"		27'-35"
101160*	10,000 lbs	132"	60"	36"	149"	205"		27'-35"
121160*	12,000 lbs	132"	60"	36"	149"	243"		27'-35"

### LIFT ACCESSORIES AVAILABLE NOT AVAILABLE

- |  |  |   |
|--|--|---|
| <input type="checkbox"/> BATTERY TRAY                  | <input checked="" type="checkbox"/> FULL LENGTH GUIDES   | <input type="checkbox"/> PONTOON RAIL KITS          |
| <input type="checkbox"/> BOW GUIDE                     | <input checked="" type="checkbox"/> HYDRAULIC BOX HOLDER | <input type="checkbox"/> PVC GUIDES                 |
| <input checked="" type="checkbox"/> BUNKS              | <input checked="" type="checkbox"/> LIFT ASSIST TOOL     | <input type="checkbox"/> SCREW LEGS                 |
| <input checked="" type="checkbox"/> CANOPY/CANOPY LEGS | <input type="checkbox"/> LIFT MOTORS                     | <input checked="" type="checkbox"/> SOLAR PANEL     |
| <input type="checkbox"/> CRADLES                       | <input type="checkbox"/> MOTOR STOP                      | <input type="checkbox"/> UNI-CADDY                  |
| <input checked="" type="checkbox"/> DEEP WATER BRACES  | <input checked="" type="checkbox"/> POLY TIRES           | <input checked="" type="checkbox"/> TRI-/QUAD-CADDY |
| <input checked="" type="checkbox"/> EXTENDED LEGS      | <input type="checkbox"/> PONTOON MOTOR STOP              |   |
| <input type="checkbox"/> FLOAT PLANE PLATFORM          | <input type="checkbox"/> PONTOON RACKS                   |   |

\*SPECIAL-ORDER

# POLYDOCK ANCHORING

## SIMPLE. QUICK. DURABLE.



### PIPE AUGERS:

Allows anchorage pipe to be augered into the lake, river, or ocean bottom. Fits 2" LD. pipe. Pipe Sold separately.



### LARGE PIPE BRACKET:

Holds dock system and ShorePorts in place when used with 2" schedule 40 galvanized pipe (sold separately). Allows the system to remain in place while adjusting for water fluctuation.



### HEAVY DUTY PIPE BRACKET WITH CHAIN GUIDE

Allows anchorage of the dock in deep water or impenetrable lake bottoms.



### SMALL PIPE BRACKET

A light duty pipe bracket perfect for small dock layouts in calm waters such as farm ponds.

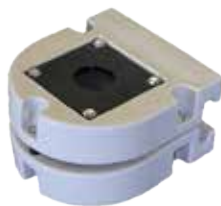

### SHOREPORT REAR PIPE BRACKET

Attaches to the rear of the ShorePort to provide additional stability to single or multiple ShorePort installations.



### STAND OFF BRACKET (PAIR)

Provides additional support for connecting PolyDock or ShorePort offset from standing docks.



### PILE HOOPS

Available in 8", 10", and 12" sizes to fit a wide range of piling installations. Includes roller system for smooth operation.



### HEAVY DUTY STIFF ARM

Anchor your dock or ShorePort to a seawall, deck, post or other abutment on shore. Galvanized pipe sold separately.



### LIGHT DUTY STIFF ARM

Anchor your dock or ShorePort to a seawall, deck, post or other abutment on shore. Perfect for light duty, calm water installations. Galvanized pipe sold separately.



### CHAIN ANCHOR PLATE

Allows you to anchor your dock system with chains affixed to deadweights. Perfect for deep and super firm waterfront locations. Connects with 6" Accessory Connector, sold separately.



### FLEXI-HINGE (PAIR)

Flexible attachment for connecting ShorePort to traditional wood or metal floating docks. For perpendicular, or front mount only.



### FLEXI-HINGE PARALLEL MOUNT

Used for attaching a ShorePort along side a traditional wood or metal floating dock. For parallel mount only.

PolyDock and ShorePort anchorage and attachment options are designed to be simple, quick and durable, and fit a wide range of waterfront applications from shallow ponds to deep reservoirs and nearly everything in between. Whether you have deep mud, or firm sand, our wide range of anchorage options can accommodate your existing piling, or a brand new PolyDock installation.

# LIFT/HOIST ACCESSORIES

MAKE YOUR DOCK AND LIFT SYSTEM WORK FOR YOU

## BOAT LIFT ACCESSORIES



FULL LENGTH GUIDES



BUNKS

Carpeted or vinyl options available



CRADLES

V-Hull, pontoon & tri-toon options



PVC GUIDES



SCREW LEGS



POLY TIRES

For both docks and lifts



MOTOR STOP



UNI-CADDY



WHEEL CADDY

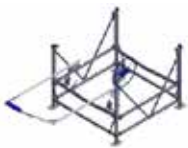

BOW GUIDE



SOLAR PANEL

12V and 24V options

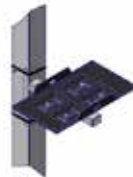

BATTERY TRAY

Leg & canopy mount option



HYDRAULIC BOX HOLDER



LIFT ASSIST TOOL



FLOAT PLANE PLATFORM

## PONTOON ACCESSORIES

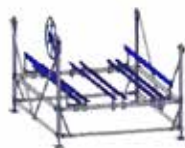

TRI-TOON CRADLE

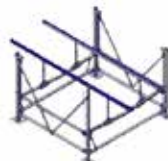

PONTOON RAIL KIT

Wood required; sold separately



PONTOON RACKS



PONTOON MOTOR STOP

# 2018 PRODUCT CATALOG

**FREE  
DELIVERY\***  
LOCAL SAME DAY



**INSTALLATION  
AVAILABLE  
WITHIN 48 HOURS**

## AUBURN

282 Poland Road  
(207) 784-4009  
1-800-HEY-AUBN  
Toll Free

## BANGOR

1087 Hammond Street  
(207) 945-9416  
1-866-HEY-BANG  
Toll Free

## BELGRADE

Route 27  
(207) 495-3303  
1-800-HEY-BELG  
Toll Free

## BOOTHBAY HARBOR

276 Townsend Ave.  
(207) 633-4474  
1-855-270-3003  
Toll Free

## BRUNSWICK

20 Spring Street  
(207) 729-9924  
1-877-341-2420  
Toll Free

## DAMARISCOTTA

511 Main Street  
(207) 563-1200  
1-855-249-3479  
Toll Free

## FAIRFIELD

5 Summit Street  
(207) 453-7322  
1-888-HEY-FAIR  
Toll Free

## FARMINGTON

Route 2  
(207) 778-3518  
1-800-HEY-FARM  
Toll Free

## GREENVILLE

Minden Street  
(207) 695-4583  
1-800-HEY-GRVL  
Toll Free

## PEMAQUID

2089 Bristol Road  
(207) 677-2652  
1-855-249-3481  
Toll Free

## PORTLAND

300 Riverside Street  
(207) 771-8880  
1-888-HEY-PTLD  
Toll Free

## SKOWHEGAN

Pennell Street  
(207) 474-8122  
1-800-HEY-SKOW  
Toll Free

## WILTON

946 Rt 2 East  
(207) 778-6969  
1-844-HEY-WILT  
Toll Free

**Hammond**  
**Lumber Company**

**WEB: [WWW.HAMMONDLUMBER.COM/SHOREMASTER](http://WWW.HAMMONDLUMBER.COM/SHOREMASTER) | EMAIL: [SHOREMASTER@HAMMONDLUMBER.COM](mailto:SHOREMASTER@HAMMONDLUMBER.COM)**

\*FREE DELIVERY WITHIN LOCAL DELIVERY AREA, SEE PAGE 72 FOR DETAILS.